

# SUPPORTING INFORMATION FOR CLOSETS

- *Closet library and configurations*
  - *Order form and instructions*
  - *QR code links to materials and other information*
- 

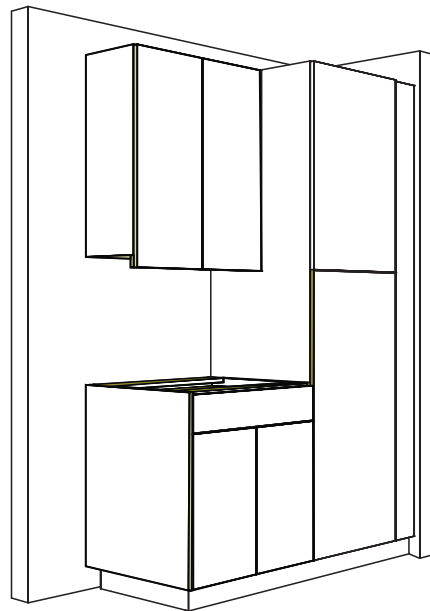

- 1 CHOOSE YOUR MATERIAL
- 2 CHOOSE YOUR DRAWER TYPES
- 3 CHOOSE YOUR FINISHES
- 4 FILL OUT OUR ORDER FORM



# 1. DOOR SPECIFICATIONS

## SLAB DOORS



### MATERIALS & COMMON BRANDS

- 1) MELAMINE GROUP A  
*White Melamine*
- 2) MELAMINE GROUP B  
*Gray Melamine*
- 3) MELAMINE GROUP C  
*American Laminates EIR*
- 4) MELAMINE GROUP D  
*Salt Linen*



## 5 PC SHAKER DOORS



### MATERIALS & COMMON BRANDS

- 1) MELAMINE GROUP A  
*White Melamine*
- 2) MELAMINE GROUP B  
*Gray Melamine*
- 3) MELAMINE GROUP C  
*American Laminates EIR*
- 4) MELAMINE GROUP D  
*Salt Linen*

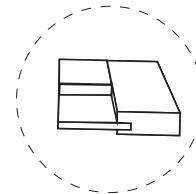

## 5 PC SHAKER GLASS DOORS



### MATERIALS & COMMON BRANDS

- 1) MELAMINE GROUP A  
*White Melamine*
- 2) MELAMINE GROUP B  
*Gray Melamine*
- 3) MELAMINE GROUP C  
*American Laminates EIR*
- 4) MELAMINE GROUP D  
*Salt Linen*

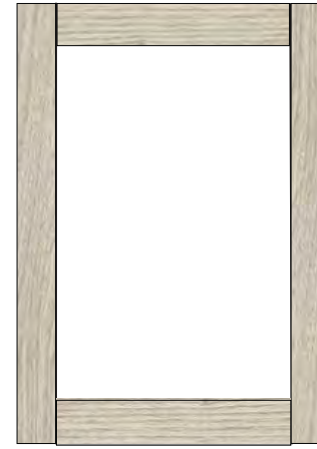

### DOORS AVAILABLE ONLY UNDER REQUEST

*\*Single doors up to 20". Pair of doors available from 20" to 42".*

*\*\*Doors on the "Hanging Section" will only be compatible with 22" to 24" depths.*

*\*\*\*Shaker Style Doors have a minimum width of 8". Any doors 8" or smaller will be changed to slab.*

**Please contact Cabinets Quick to check any material & sample availability or to place a sample order.**

## 2. CLOSET FINISHES

### 1. MELAMINE GROUP A - WHITE MELAMINE

*\*Suggested use for Top, Bottom, Left End, Right End and Middle Panel.*



### 2. MELAMINE GROUP B - GRAY MELAMINE

*\*Suggested use for Top, Bottom, Left End, Right End and Middle Panel.*



## 2. CLOSET FINISHES

### 3. MELAMINE GROUP C - AMERICAN LAMINATES EIR COLLECTION

*\*Suggested use for Shelves, Doors and Drawers Fronts.*

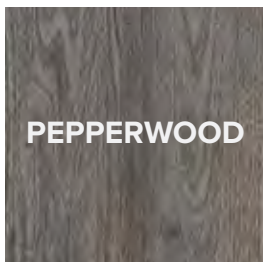
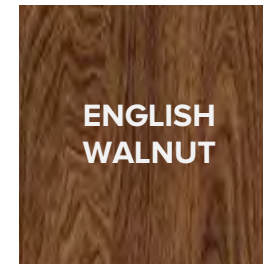
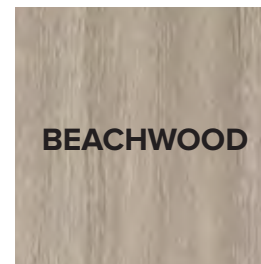
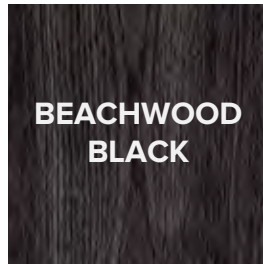
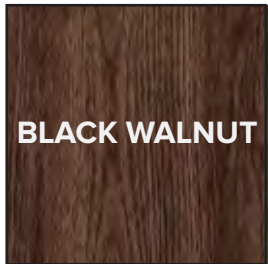

*\*Scan the QR CODE and find  
out more AMLAM finishes*

### 4. MELAMINE GROUP D - SALT LINEN COLLECTION

*\*Suggested use for Shelves, Doors and Drawers Fronts.*

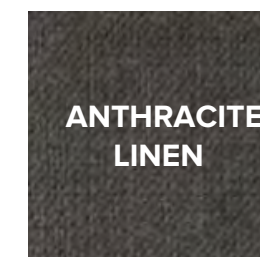

*\*Scan the QR CODE and find  
out more SALT finishes*

# 3. CLOSET CONFIGURATIONS



## HANGING SECTION

	<b>SINGLE HANGING UNIT</b>	<b>SKU</b>	<b>DIMENSIONS</b> <i>*BEST PRACTICE NOMINAL SIZES OPEN FOR</i>
<b>1 HANGING UNIT</b>	<p>- Bottom Opening is 39 5/8"</p> <p>- There is a 2 3/8" clearance between top of the rod and the bottom of the shelf</p>	<b>C: H - SINGLE - 84</b>	<p><b>W:</b> from 12" to 42"</p> <p><b>D:</b> between 14" and 24" <i>*(CQ Default) is 16"</i></p> <p><b>H:</b> 84"</p>
	<p>- Bottom Opening is 59 3/4"</p> <p>- There is a 2 3/8" clearance between top of the rod and the bottom of the shelf</p>		

	<b>DOUBLE HANGING UNIT</b>	<b>SKU</b>	<b>DIMENSIONS</b> <i>*BEST PRACTICE NOMINAL SIZES OPEN FOR</i>
<b>2 HANGING UNITS</b>	<p>- Bottom Opening is 39 5/8"</p> <p>- There is a 2 3/8" clearance between top of the rod and the bottom of the shelf</p>	<b>C: H - DOUBLE - 84</b>	<p><b>W:</b> from 12" to 42"</p> <p><b>D:</b> between 14" and 24" <i>*(CQ Default) is 16"</i></p> <p><b>H:</b> 84"</p>
	<p>- Bottom Opening is 59 3/4"</p> <p>- There is a 2 3/8" clearance between top of the rod and the bottom of the shelf</p>		

# 3. CLOSET CONFIGURATIONS

HANGING SECTION

SINGLE TALL HANGING UNIT		SKU	DIMENSIONS *BEST PRACTICE NOMINAL SIZES OPEN FOR
1 HANGING UNIT	<ul style="list-style-type: none"> <li>- Bottom Opening is 39 5/8"</li> <li>- There is a 2 3/8" clearance between top of the rod and the bottom of the shelf</li> </ul> 	C: H - SINGLE TALL - 84	<p><b>W:</b> from 12" to 42"</p> <p><b>D:</b> between 14" and 24" *(CQ Default) is 16"</p> <p><b>H:</b> 84"</p>
	<ul style="list-style-type: none"> <li>- Bottom Opening is 59 3/4"</li> <li>- There is a 2 3/8" clearance between top of the rod and the bottom of the shelf</li> </ul> 		<p><b>W:</b> from 12" to 42"</p> <p><b>D:</b> between 14" and 24" *(CQ Default) is 16"</p> <p><b>H:</b> 96"</p>

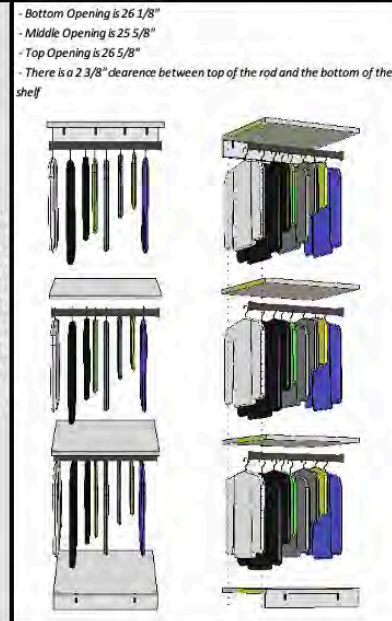
TRIPLE HANGING UNIT		SKU	DIMENSIONS *BEST PRACTICE NOMINAL SIZES OPEN FOR
3 HANGING UNITS	<ul style="list-style-type: none"> <li>- Bottom Opening is 26 1/8"</li> <li>- Middle Opening is 25 5/8"</li> <li>- Top Opening is 26 5/8"</li> <li>- There is a 2 3/8" clearance between top of the rod and the bottom of the shelf</li> </ul> 	C: H - TRIPLE - 84	<p><b>W:</b> from 12" to 42"</p> <p><b>D:</b> between 14" and 24" *(CQ Default) is 16"</p> <p><b>H:</b> 84"</p>

# 3. CLOSET CONFIGURATIONS

## DRAWER SECTION

3 EQUAL DRAWERS HANGING UNIT		SKU	DIMENSIONS *BEST PRACTICE NOMINAL SIZES OPEN FOR
3 DRAWERS	<ul style="list-style-type: none"> <li>- Top Drawer Front Height is 13 3/4"</li> <li>- (2x) Bottom Drawers Front Height is 12 1/2"</li> <li>- Top Opening is 39 5/8"</li> <li>- There is a 2 3/8" clearance between top of the rod and the bottom of the shelf</li> </ul>	C: 3 EQL DWR - 84	<b>W:</b> from 16" to 24" <b>D:</b> between 18" and 24" *(CQ Default) is 18" <b>H:</b> 84"
3 DRAWERS		C: 3 EQL DWR - 96	<b>W:</b> from 16" to 24" <b>D:</b> between 18" and 24" *(CQ Default) is 18" <b>H:</b> 96"

4 EQUAL DRAWERS HANGING UNIT		SKU	DIMENSIONS *BEST PRACTICE NOMINAL SIZES OPEN FOR
4 DRAWERS	<ul style="list-style-type: none"> <li>- (4x) Drawer Front Height is 10"</li> <li>- Top Opening is 39 5/8"</li> <li>- There is a 2 3/8" clearance between top of the rod and the bottom of the shelf</li> </ul>	C: 4 EQL DWR - 84	<b>W:</b> from 16" to 24" <b>D:</b> between 18" and 24" *(CQ Default) is 18" <b>H:</b> 84"
4 DRAWERS		C: 4 EQL DWR - 96	<b>W:</b> from 16" to 24" <b>D:</b> between 18" and 24" *(CQ Default) is 18" <b>H:</b> 96"

# 3. CLOSET CONFIGURATIONS

## DRAWER SECTION



1 TOP DRAWER - 3 EQUAL BOTTOM DRW. HANING UNIT		SKU	DIMENSIONS <i>*BEST PRACTICE NOMINAL SIZES OPEN FOR</i>
<b>4 DRAWERS</b>	<ul style="list-style-type: none"> <li>- (1x) Top Drawer Front Height is 6 1/8"</li> <li>- (3x) Bottom Drawers Front Height is 11 1/4"</li> <li>- Top Opening is 39 5/8"</li> <li>- There is a 2 3/8" clearance between top of the rod and the bottom of the shelf</li> </ul>	<b>C: 1 TOP - 3 EQL DWR - 84</b>	<p><b>W:</b> from 16" to 24"</p> <p><b>D:</b> between 18" and 24" <i>*(CQ Default) is 18"</i></p> <p><b>H:</b> 84"</p>
			<p><b>W:</b> from 16" to 24"</p> <p><b>D:</b> between 18" and 24" <i>*(CQ Default) is 18"</i></p> <p><b>H:</b> 96"</p>

2 TOP DRAWERS - 2 EQUAL BOTTOM DRW HANING UNIT		SKU	DIMENSIONS <i>*BEST PRACTICE NOMINAL SIZES OPEN FOR</i>
<b>4 DRAWERS</b>	<ul style="list-style-type: none"> <li>- (2x) Top Drawer Front Height is 6 1/8"</li> <li>- (2x) Bottom Drawers Front Height is 13 3/4"</li> <li>- Top Opening is 39 5/8"</li> <li>- There is a 2 3/8" clearance between top of the rod and the bottom of the shelf</li> </ul>	<b>C: 2 TOP - 2 EQL DWR - 84</b>	<p><b>W:</b> from 12" to 24"</p> <p><b>D:</b> between 18" and 24" <i>*(CQ Default) is 18"</i></p> <p><b>H:</b> 84"</p>
			<p><b>W:</b> from 12" to 24"</p> <p><b>D:</b> between 18" and 24" <i>*(CQ Default) is 18"</i></p> <p><b>H:</b> 96"</p>

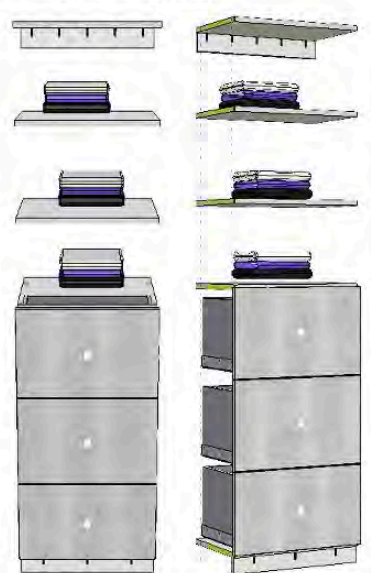

# 10. CLOSET CONFIGURATIONS

## DRAWER SECTION

3 EQUAL DRAWERS 2 ADJ. SHELVES		SKU	DIMENSIONS <i>*BEST PRACTICE NOMINAL SIZES OPEN FOR</i>
3 DRAWERS	<p>- Top Drawer Front Height is 13 3/4" - (2x) Bottom Drawers Front Height is 12 1/2"</p> 	C: 3 EQL DWR - 2 ADJ - 84	<p><b>W:</b> from 16" to 24"</p> <p><b>D:</b> between 18" and 24" <i>*(CQ Default) is 18"</i></p> <p><b>H:</b> 84"</p>
			<p><b>W:</b> from 16" to 24"</p> <p><b>D:</b> between 18" and 24" <i>*(CQ Default) is 18"</i></p> <p><b>H:</b> 96"</p>

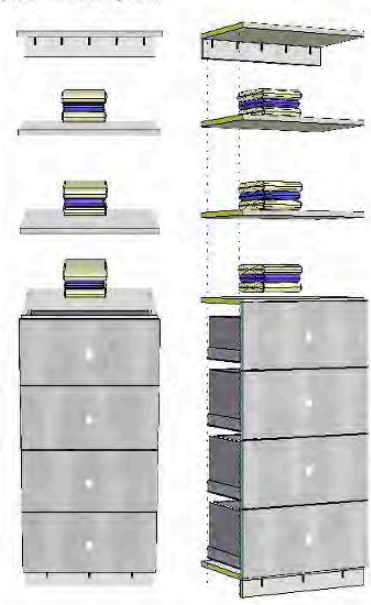
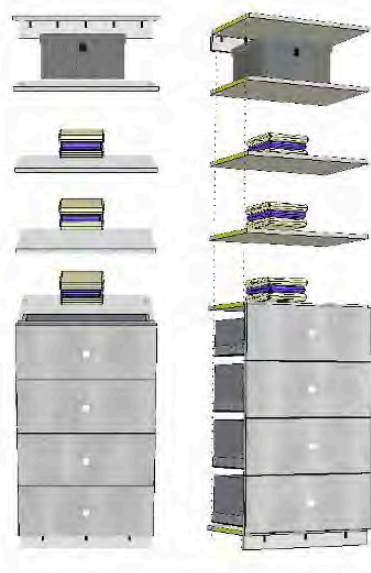
4 EQUAL DRAWERS 2 ADJ. SHELVES		SKU	DIMENSIONS <i>*BEST PRACTICE NOMINAL SIZES OPEN FOR</i>
4 DRAWERS	<p>- (4x) Drawer Front Height is 10"</p> 	C: 4 EQL DWR - 2 ADJ - 84	<p><b>W:</b> from 16" to 24"</p> <p><b>D:</b> between 18" and 24" <i>*(CQ Default) is 18"</i></p> <p><b>H:</b> 84"</p>
			<p><b>W:</b> from 16" to 24"</p> <p><b>D:</b> between 18" and 24" <i>*(CQ Default) is 18"</i></p> <p><b>H:</b> 96"</p>

# 3. CLOSET CONFIGURATIONS

## DRAWER SECTION

1 TOP DRAWER - 3 EQUAL BOTTOM DRW - 2 ADJ. SHELVES		SKU	DIMENSIONS <i>*BEST PRACTICE NOMINAL SIZES OPEN FOR</i>
4 DRAWERS	<p>- (1x) Top Drawer Front Height is 6 1/8" - (3x) Bottom Drawers Front Height is 11 1/4"</p>	C: 1 TOP - 3 EQL DWR - 2 ADJ - 84	<p><b>W:</b> from 16" to 24"</p> <p><b>D:</b> between 18" and 24" <i>*(CQ Default) is 18"</i></p> <p><b>H:</b> 84"</p>
			<p><b>W:</b> from 16" to 24"</p> <p><b>D:</b> between 18" and 24" <i>*(CQ Default) is 18"</i></p> <p><b>H:</b> 84"</p>
4 DRAWERS	<p>- (2x) Top Drawer Front Height is 6 1/8" - (2x) Bottom Drawers Front Height is 13 3/4"</p>	C: 2 TOP - 2 EQL DWR - 2 ADJ - 84	<p><b>W:</b> from 16" to 24"</p> <p><b>D:</b> between 18" and 24" <i>*(CQ Default) is 18"</i></p> <p><b>H:</b> 84"</p>
			<p><b>W:</b> from 16" to 24"</p> <p><b>D:</b> between 18" and 24" <i>*(CQ Default) is 18"</i></p> <p><b>H:</b> 84"</p>
4 DRAWERS		C: 1 TOP - 3 EQL DWR - 2 ADJ - 96	<p><b>W:</b> from 16" to 24"</p> <p><b>D:</b> between 18" and 24" <i>*(CQ Default) is 18"</i></p> <p><b>H:</b> 96"</p>
			<p><b>W:</b> from 16" to 24"</p> <p><b>D:</b> between 18" and 24" <i>*(CQ Default) is 18"</i></p> <p><b>H:</b> 96"</p>
4 DRAWERS		C: 2 TOP - 2 EQL DWR - 2 ADJ - 96	<p><b>W:</b> from 16" to 24"</p> <p><b>D:</b> between 18" and 24" <i>*(CQ Default) is 18"</i></p> <p><b>H:</b> 96"</p>
			<p><b>W:</b> from 16" to 24"</p> <p><b>D:</b> between 18" and 24" <i>*(CQ Default) is 18"</i></p> <p><b>H:</b> 96"</p>

# 3. CLOSET CONFIGURATIONS



## DRAWER SECTION



1 TOP DRAWER - 3 EQUAL BOTTOM DRW - SHOE RACK		SKU	DIMENSIONS *BEST PRACTICE NOMINAL SIZES OPEN FOR
4 DRAWERS	<p>- (1x) Top Drawer Front Height is 6 1/8" - (3x) Bottom Drawers Front Height is 11 1/4"</p>	<b>C: 1 TOP - 3 EQL DWR - 3 SHOE - 84</b>	<p><b>W:</b> from 16" to 24" <b>D:</b> between 18" and 24" <i>*(CQ Default) is 18"</i> <b>H:</b> 84"</p>
		<b>C: 1 TOP - 3 EQL DWR - 3 SHOE - 96</b>	<p><b>W:</b> from 16" to 24" <b>D:</b> between 18" and 24" <i>*(CQ Default) is 18"</i> <b>H:</b> 96"</p>

2 TOP DRAWERS SHOE RACK		SKU	DIMENSIONS *BEST PRACTICE NOMINAL SIZES OPEN FOR
2 DRAWERS	<p>- (2x) Drawers Front Height is 6 1/8" - Top Opening is 39 5/8" - There is a 2 3/8" clearance between top of the rod and the bottom of the shelf</p>	<b>C: 2 TOP - 2 SHOE - 84</b>	<p><b>W:</b> from 16" to 24" <b>D:</b> between 18" and 24" <i>*(CQ Default) is 18"</i> <b>H:</b> 84"</p>
		<b>C: 2 TOP - 2 SHOE - 96</b>	<p><b>W:</b> from 16" to 24" <b>D:</b> between 18" and 24" <i>*(CQ Default) is 18"</i> <b>H:</b> 96"</p>

# 3. CLOSET CONFIGURATIONS

## HAMPER SECTION

1 TOP DRAWER - HAMPER		SKU	DIMENSIONS *BEST PRACTICE NOMINAL SIZES OPEN FOR
1 DRAWER	<ul style="list-style-type: none"> <li>- Drawer Front Height is 12 1/2"</li> <li>- Hamper Front Height is 27 5/8"</li> <li>- Top Opening is 39 5/8"</li> <li>- There is a 2 3/8" clearance between top of the rod and the bottom of the shelf</li> </ul> 	C: 1 TOP DWR - HAMPER - 84	<p><b>W:</b> from 18" to 24"</p> <p><b>D:</b> between 18" and 24" *(CQ Default) is 18"</p> <p><b>H:</b> 84"</p>
			

2 TOP DRAWER - HAMPER		SKU	DIMENSIONS *BEST PRACTICE NOMINAL SIZES OPEN FOR
2 DRAWERS	<ul style="list-style-type: none"> <li>- (2x) Drawers Front Height is 6 1/8"</li> <li>- Hamper Front Height is 27 5/8"</li> <li>- Top Opening is 39 5/8"</li> <li>- There is a 2 3/8" clearance between top of the rod and the bottom of the shelf</li> </ul> 	C: 2 TOP DWR - HAMPER - 84	<p><b>W:</b> from 18" to 24"</p> <p><b>D:</b> between 18" and 24" *(CQ Default) is 18"</p> <p><b>H:</b> 84"</p>
			

# 3. CLOSET CONFIGURATIONS

## HAMPER SECTION

3 ADJ. SHELVES - HAMPER		SKU	DIMENSIONS <i>*BEST PRACTICE NOMINAL SIZES OPEN FOR</i>
3 ADJ. SHELVES	<p>- Hamper Front Height is 27 5/8"</p>	C: HAMPER - 3 ADJ - 84	<b>W:</b> from 18" to 24" <b>D:</b> between 18" and 24" <i>*(CQ Default) is 18"</i> <b>H:</b> 84"
		C: HAMPER - 3 ADJ - 96	<b>W:</b> from 18" to 24" <b>D:</b> between 18" and 24". <i>*(CQ Default) is 18"</i> <b>H:</b> 96"
1 TOP DRAWER 2 ADJ. SHELVES - HAMPER		SKU	DIMENSIONS <i>*BEST PRACTICE NOMINAL SIZES OPEN FOR</i>
1 DRAWER	<p>- Drawer Front Height is 12 1/2" - Hamper Front Height is 27 5/8"</p>	C: 2 TOP DWR - HAMPER - 2 ADJ - 84	<b>W:</b> from 18" to 24" <b>D:</b> between 18" and 24" <i>*(CQ Default) is 18"</i> <b>H:</b> 84"
		C: 2 TOP DWR - HAMPER - 2 ADJ - 96	<b>W:</b> from 18" to 24" <b>D:</b> between 18" and 24" <i>*(CQ Default) is 18"</i> <b>H:</b> 96"

# 3. CLOSET CONFIGURATIONS

## HAMPER SECTION

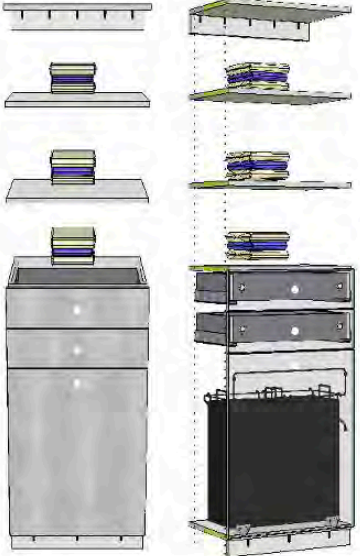
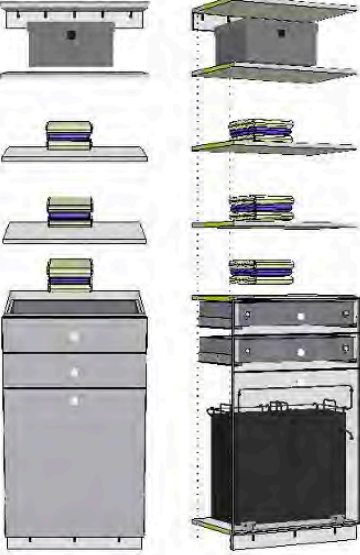
<b>2 TOP DRAWERS</b> <b>2 ADJ. SHELVES - HAMPER</b>	<b>SKU</b>	<b>DIMENSIONS</b> <i>*BEST PRACTICE NOMINAL            SIZES OPEN FOR</i>
<div style="display: flex; align-items: center;"> <div style="writing-mode: vertical-rl; transform: rotate(180deg); font-weight: bold; margin-right: 10px;">2 DRAWERS</div> <div style="flex-grow: 1;"> <p style="font-size: small; margin-bottom: 5px;">- (2x) Drawers Front Height is 6 1/8"</p> <p style="font-size: small; margin-bottom: 5px;">- Hamper Front Height is 27 5/8"</p>  </div> </div>	<b>C: 2 TOP DWR - HAMPER - 2 ADJ - 84</b>	<p><b>W:</b> from 18" to 24"</p> <p><b>D:</b> between 18" and 24"  <i>*(CQ Default) is 18"</i></p> <p><b>H:</b> 84"</p>
<div style="display: flex; align-items: center;"> <div style="writing-mode: vertical-rl; transform: rotate(180deg); font-weight: bold; margin-right: 10px;">2 DRAWERS</div> <div style="flex-grow: 1;">  </div> </div>	<b>C: 2 TOP DWR - HAMPER - 2 ADJ - 96</b>	<p><b>W:</b> from 18" to 24"</p> <p><b>D:</b> between 18" and 24"  <i>*(CQ Default) is 18"</i></p> <p><b>H:</b> 96"</p>

# 3. CLOSET CONFIGURATIONS

## SHELF SECTION

5 ADJUSTABLE SHELVES		SKU	DIMENSIONS <i>*BEST PRACTICE NOMINAL SIZES OPEN FOR</i>
5 ADJ. SHELVES		C: 5 ADJ - 84	<b>W:</b> from 12" to 42" <b>D:</b> between 10" and 24" <i>*(CQ Default) is 16"</i> <b>H:</b> 84"
6 ADJ. SHELVES		C: 6 ADJ - 84	<b>W:</b> from 12" to 42" <b>D:</b> between 10" and 24" <i>*(CQ Default) is 16"</i> <b>H:</b> 84"
5 ADJ. SHELVES		C: 5 ADJ - 96	<b>W:</b> from 12" to 42" <b>D:</b> between 10" and 24" <i>*(CQ Default) is 16"</i> <b>H:</b> 96"
6 ADJ. SHELVES		C: 6 ADJ - 96	<b>W:</b> from 12" to 42" <b>D:</b> between 10" and 24" <i>*(CQ Default) is 16"</i> <b>H:</b> 96"

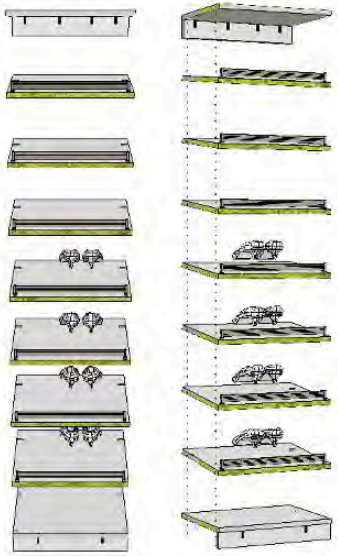
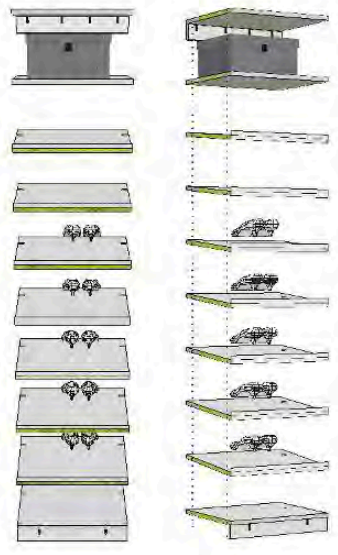

# 3. CLOSET CONFIGURATIONS

## SHELF SECTION

7 SHOE SHELVES		SKU	DIMENSIONS <i>*BEST PRACTICE NOMINAL SIZES OPEN FOR</i>
7 SHOE SHELVES		C: 7 SHOE SHELF - 84	<p><b>W:</b> from 12" to 42"</p> <p><b>D:</b> between 10" and 24" <i>*(CQ Default) is 16"</i></p> <p><b>H:</b> 84"</p>
7 SHOE SHELVES		C: 7 SHOE SHELF - 96	<p><b>W:</b> from 12" to 42"</p> <p><b>D:</b> between 10" and 24" <i>*(CQ Default) is 16"</i></p> <p><b>H:</b> 96"</p>



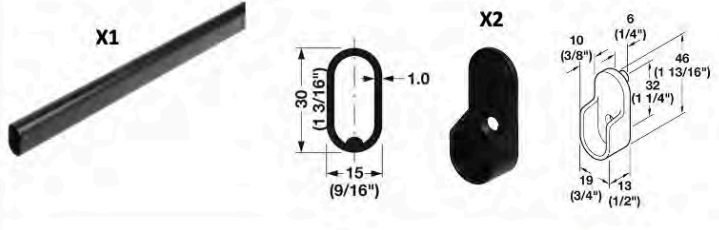

# 4. CLOSET ACCESSORIES

WELDED STEEL OVAL WARDROBE TUBE, STEEL	SKU	DIMENSIONS	PRCINO
	801.13.309	<b>LENGTH:</b> 92" <b>HEIGHT:</b> 1 3/16" <b>COLOR:</b> BLACK	\$13.50
	801.13.201	<b>LENGTH:</b> 92" <b>HEIGHT:</b> 1 3/16" <b>COLOR:</b> CHROME	\$11.00

VALET, TAG SYNERGY ELITE COLLECTION	SKU	DIMENSIONS	PRICING
	808.71.501	<b>WIDTH:</b> 12" <b>COLOR:</b> BLACK	\$35.00
	808.71.401	<b>WIDTH:</b> 12" <b>COLOR:</b> CHROME	\$33.00

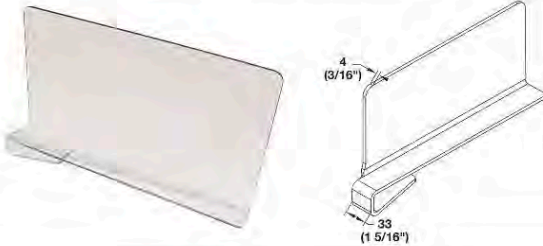

# 4. CLOSET ACCESSORIES

SHELF DIVIDERS	SKU	DIMENSIONS	PRICING
	771.80.431	<b>HEIGHT:</b> 5" <b>DEPTH:</b> 12" <b>MATERIAL:</b> ACRYLIC	\$32.00
	771.80.436	<b>HEIGHT:</b> 8" <b>DEPTH:</b> 14" <b>MATERIAL:</b> ACRYLIC	\$30.00

WARDROBE LIFT, 26 LBS. WEIGHT CAPACITY	SKU	DIMENSIONS	PRICING
	805.31.201	<b>DIAMETER:</b> Tube is 7/8" <b>HEIGHT:</b> 19 3/8"/9 11/16" <b>FOR INTERNAL CABINET WIDTH:</b> 21 1/4" - 26"	\$111.00
	805.31.302	<b>DIAMETER:</b> Tube is 7/8" <b>HEIGHT:</b> 19 3/8"/9 11/16" <b>FOR INTERNAL CABINET WIDTH:</b> 26" - 35 1/16"	\$107.00

# 4. CLOSET ACCESSORIES

JEWELRY TRAY	SKU	DIMENSIONS	PRICING
	811.03.301	<b>WIDTH:</b> 23" <b>DEPTH:</b> 14" <b>COLOR:</b> BLACK	<b>\$118.00</b>
	807.77.011	<b>WIDTH:</b> 23" <b>DEPTH:</b> 14" <b>COLOR:</b> GRAY	<b>\$114.00</b>

BELT TRAY	SKU	DIMENSIONS	PRICING
 	811.03.513	<b>WIDTH:</b> 23" <b>DEPTH:</b> 14" <b>COLOR:</b> GRAY FELT	<b>\$118.00</b>
	811.03.530	<b>WIDTH:</b> 23" <b>DEPTH:</b> 14" <b>COLOR:</b> GRAY	<b>\$114.00</b>

## 5. TERMS AND CONDITIONS



**PAYMENT.** A 50% deposit on all orders, due at the time of acknowledgment of approval. The deposit must be received prior to production. We require that the remaining balance must be paid prior to pick up or shipment. Deposit and/or final payment may be made by: Cash, Check, Cashiers Check, Credit Card. We accept Visa and Master Card. If sending a check or cashiers check, orders may be delayed until funds clear the bank.

**Please note, absence of a deposit will delay production and absence of final payment will delay pick up or shipping.**

**ORDER PROCESSING.** Phone orders are not accepted due to the many errors that may arise from miscommunication. Please check your order form carefully for item size, quantity, color, etc. Your order will be processed sent for your acknowledgment, which must be signed and returned.

**REVISIONS.** Your order or estimate will be entered and then allow first and second customer revision ( acknowledgment ) for no additional charge. Any additional customer required revisions will require a fee of \$60 per revision cycle. Each time an order or estimate is revised it will be re-acknowledged. Any revision charges will be clearly shown on the latest acknowledgment.

**LEAD TIME.** Lead time varies depending on the current production schedule. More accurate lead times will be given when order is approved. Every reasonable attempt to ship by projected ship date will be made, but may be affected by special ordered material, non-payment of deposit, numerous revisions to an order, etc.

**RUSH ORDER SERVICES.** Rush Orders will be available for orders under 50 cabinet. Rush orders may be requested, but availability is not always guaranteed. Rush Order requests may be made for an additional 25%, with the minimum fee being \$500.

**CHANGES TO APPROVED ORDERS.** Requested revisions after an order is signed and approved by customer are never guaranteed. If the order is already in production, customers will incur a net charge based on time and any materials which may be affected.

**SHIPPING AND HANDING.** Because of the nature of our custom orders, it is impossible to determine the exact cost for shipping each order until the order is completed. We strive to provide our customers with the safest and most affordable means in all deliveries. Please be advised that delivery is not included in the price of the cabinets and all shipping charges are the responsibility of the customer. Customer should verify that the delivery truck can safely drive on all roads leading up to delivery destination. If inaccessible for any reason deemed necessary by the driver, customer is responsible for picking up their order from the shipping distribution center.

**DELIVERY AND INSPECTION.** Buyer shall have the right to inspect the goods with in five (5) days of delivery at the shipping address. Please note, after 5 days any order discrepancies are void. No exceptions. All products leave our factory in good condition and properly packaged. All claims for damaged or broken merchandise must be made through carrier. Any damage that is apparent up on delivery must be noted over the freight carrier delivery receipt. If the damage is severe ,we recommend you refuse the shipment entirely. All claims for damaged or broken merchandise must be made through carrier.

**INSTALLATION.** We do not accept responsibility or liability for installation of any product. We recommend using a professional installer for best results. Cabinets Quick is not responsible for problems arising from improper installation, use or care.

# 6. WARRANTY



## LIMITED LIFETIME WARRANTY

Cabinets Quick here by warrants to the first and original purchaser, for residential applications only, that all cabinets, including system hardware, are free from defects in materials and workmanship for a period of (10) years and all doors and drawer fronts for a period of (1) year. This warranty is expressly limited to repair or replacement of the defective part at the sole discretion of Cabinets Quick and does not include labor for removal or replacement. This warranty does not extend to defects caused by improper handling, storage, installation, assembly or disassembly, intentional damage, product modifications, exposure to the elements including humidity which may result in warping or splitting, accidental misuse, abuse or negligence.

LIFETIME. Cabinets Quick offers a lifetime warranty for all Soft Close Hinges and Drawer Guides. This warranty runs for as long as you own your cabinets and begins upon the date of delivery to you.

**Heat & Humidity.** Various cooking appliances produce a lot of heat or humidity. It is very important to make sure these products are positioned so rising heat is not trapped or confined. Thermofoil and edge-banding on doors cannot be exposed to temperatures beyond 170 degrees for extended periods of time without risking permanent damage, which are not covered under the warranty.

**Sunlight and Aging.** Materials may vary in texture, color and wood grain, and exhibit subtle changes as they age. For example, wood joints may eventually have visible cracking around the joint area and cabinet colors may darken or lighten over time. Sunlight, smoke, moisture, household cleaners and other environmental conditions may cause materials to vary from their original color and/or to warp, split or crack. These variations are considered to be the nature of the material in relation to their environmental exposure and are not covered under this warranty.

Cabinets Quick makes no other warranties other than those set forth herein and all other warranties are hereby disclaimed. The implied warranties of merchantability and fitness for a particular purpose are limited in duration to the length of the limited warranty period. The limited warranties set forth herein are restricted to the first and original buyer and are not transferable thereafter. In no event shall Cabinets Quick be liable for incidental or consequential damages to the purchaser or to any third party, including, without limitation, damages arising from personal injury, lost profits, loss of business opportunity, loss of property, economic losses, or statutory or exemplary damages, whether from negligence, warranty, strict liability or otherwise. Some states do not allow the exclusion or limitation of incidental or consequential damages, or limitations on how long an implied warranty lasts, so the above limitations and exclusions may not apply to you. This warranty gives you specific legal rights, and you may also have other rights which vary from state to state. All claims for defective cabinets and accessories must be submitted to Cabinets Quick in writing and must specify the defects present in the cabinets and accessories. After Cabinets Quick has had an opportunity to inspect the cabinets and accessories, they will, at their sole discretion, either replace effective cabinets and accessories or repair any defects in the cabinets and accessories.

# 7. CARE AND MAINTENANCE



**EVERY DAY CARE.** It is important to wipe up spills and water marks as they occur. Give special attention to care as around the sink and dishwasher. Avoid draping damp or wet dish towels over the door of a sink base cabinet. Over time, this moisture can cause permanent water damage to the door. A convenient, out-of-the-way sliding towel rack is recommended.

**DUSTING.** Dust cabinets frequently with a soft lint-free cloth. You can dampen the cloth slightly with water or spray-type dust remover.

**SPILLS.** Clean spills immediately. Use a clean cloth and mild soap if necessary. Wipe dry with a clean soft cloth.

**CLEANING.** There are a number of products available for your wood cleaning needs. Many wood cleaning products are available at many stores nation wide including Bed Bath & Beyond, Walmart and Ace Hardware. A more economical way to remove grease build up over cabinets is to use Fantastik. Apply and remove quickly, then wash your cabinets with a mild soap. After washing, dry thoroughly.

**DON'T.** Never use detergents, soap pads or steel wool on your cabinetry. These harsh abrasives will mar the wood finish. Additionally, we recommend that you avoid the use of paste wax and polishes that contain silicone; the wax build up is difficult to remove and will leave a residue that attracts dust.

**ACRYLIC.** Never use Acetone or Ammonia-based product son Acrylic Panels. Wipe with scratch resistant microfiber clothes with mild detergents ONLY. In the event that your surfaces gets crotched, you may purchase one of our scratch kits.

* PROJECT NAME:	* CONTACT NAME:	* QUOTE DUE DATE:
* COMPANY NAME:	* PHONE:	EMAIL:
* CONTACT ADDRESS:	* PROJECT STATUS: <input type="checkbox"/> GENERAL BIDDING <input type="checkbox"/> PROJECT IN PROGRESS	

**DISCLOSURE:** All quotes and drawings are Cabinets Quick's property until the job is approved. All quotes are free of charge. A maximum of 2 changes per quote will be allowed. For more than 2 changes per quote a deposit will be required. CQ defaults are designed to give you a configuration that will serve well for most applications. The Rest of options displayed here are not upgrades but are alternatives to the CQ defaults. For upgrades or any additional instructions regarding your project please contact our office by phone or email.

BY SELECTING THIS OPTION CABINETS QUICK WILL FOLLOW OUR TYPICAL CONSTRUCTION STANDARDS **(CQ DEFAULT)** ONLY DOOR **MATERIALS** WILL NEED TO BE SELECTED.

<p><b>A) CASE MATERIAL</b></p> <p>Please select the <b>finish material</b> from bellow:</p> <p><input type="checkbox"/> <b>Melamine GROUP A</b> (White Melamine) -&gt; Best price value</p> <p><input type="checkbox"/> <b>Melamine GROUP B</b> (Fog Gray or Storm Gray Melamine) -&gt; \$</p> <p><input type="checkbox"/> <b>Melamine GROUP C</b> (American Laminates EIR) -&gt; \$\$</p> <p><input type="checkbox"/> <b>Melamine GROUP D</b> (Salt Linen Collection) -&gt; \$\$\$</p>	<p><b>B) DOOR MATERIALS</b></p> <p><input type="checkbox"/> YES (CQ DEFAULT) <input type="checkbox"/> NO If <b>YES</b> please select from the followings:</p> <p><input type="checkbox"/> <b>SLAB DOORS</b> <input type="checkbox"/> <b>5 PIECE SHAKER DOORS</b> <b>SLAB GLASS DOORS</b> <b>5 PIECE SHAKER GLASS DOORS</b></p> <hr style="border-top: 1px dashed black;"/> <p>Please select the <b>finish material</b> from bellow:</p> <p><input type="checkbox"/> <b>Melamine GROUP A</b> (White Melamine) -&gt; Best price value</p> <p><input type="checkbox"/> <b>Melamine GROUP B</b> (Fog Gray or Storm Gray Melamine) -&gt; \$</p> <p><input type="checkbox"/> <b>Melamine GROUP C</b> (American Laminates EIR) -&gt; \$\$</p> <p><input type="checkbox"/> <b>Melamine GROUP D</b> (Salt Linen Collection) -&gt; \$\$\$</p>	<p><b>C) PROVIDE DRAWERS</b></p> <p><input type="checkbox"/> YES (CQ DEFAULT) <input type="checkbox"/> NO If <b>YES</b> please select from the followings:</p> <p><input type="checkbox"/> - 1/2" Birch Imp Assembled Dovetail Construction (CQ DEFAULT)</p> <p><input type="checkbox"/> - HAFELE Matrix Slim Metal Box <small>*Drawers require onsite assembly</small></p>
---	---	---

<p><b>E) GLASS SHELF</b></p> <p><b>UPGRADE TO GLASS SHELF:</b></p> <p><input type="checkbox"/> YES <input type="checkbox"/> NO</p> <hr style="border-top: 1px dashed black;"/> <p>If <b>YES</b> please select from the followings:</p> <p><b>- GLASS TYPE:</b></p> <p><input type="checkbox"/> Clear: recommended for lighting clothes and display items</p> <p><input type="checkbox"/> Smoked</p> <p><input type="checkbox"/> Bronze: recommended for lighting under shelves and general lighting.</p> <p><b>- ALUMINUM FRAME:</b></p> <p><input type="checkbox"/> Clear Aluminum</p> <p><input type="checkbox"/> Black Aluminum</p>	<p><b>F) OTHER FEATURES</b></p> <p><b>DELIVER THE PROJECT</b></p> <p><input type="checkbox"/> YES <input type="checkbox"/> NO (WILL CALL - CQ DEFAULT)</p> <p><small>*Shipping price will be determined after finished job is weighed.</small></p> <p><b>BUY GLASS SAMPLE KIT</b></p> <p><input type="checkbox"/> YES (\$30 - including shipping) <input type="checkbox"/> NO</p> <p><small>*Glass sample kit import will be fully refunded once the project gets approved</small></p> <p><small>**For more information about the LED GLASS shelf please scan the QR Code bellow:</small></p> <div style="text-align: center;">  </div>	<p><b>G) CLOSET ACCESSORIES</b></p> <table border="1" style="width:100%; border-collapse: collapse;"> <thead> <tr> <th style="width:70%;">SKU</th> <th style="width:30%;">QTY</th> </tr> </thead> <tbody> <tr><td> </td><td> </td></tr> <tr><td> </td><td> </td></tr> <tr><td> </td><td> </td></tr> <tr><td> </td><td> </td></tr> <tr><td> </td><td> </td></tr> <tr><td> </td><td> </td></tr> <tr><td> </td><td> </td></tr> <tr><td> </td><td> </td></tr> </tbody> </table>	SKU	QTY																
SKU	QTY																			

Cabinets Quick CLOSET SKU #	Quantity	Width	Height - 84" or 96"	Depth (excluding doors)	Upgrade to LED Glass Shelf: YES/NO	Mark with an x for Glass Doors	Hinge Location: Left, Right	Company Name	Project Name or Number	Room Name or Number
								MAKE COMMENTS ADD ADDITIONAL INSTRUCTIONS (Glass Shelves, Shoe Shelves, Hampers..etc)		