

# SUPPORTING INFORMATION FOR KITCHEN CABINETS

- *Cabinet library and configurations*
  - *Order form and instructions*
  - *QR code links to materials and other information*
- 

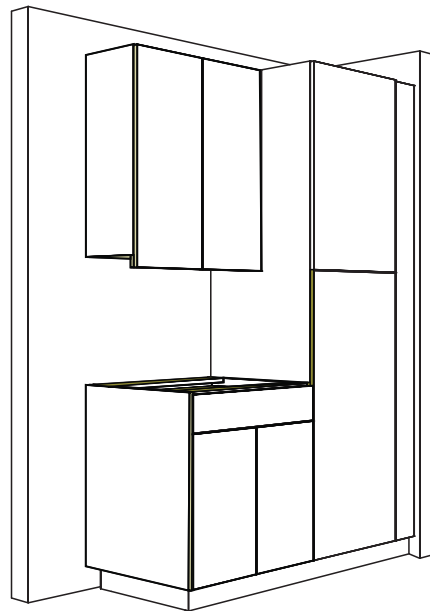

- 1 CHOOSE YOUR CASE MATERIAL
- 2 CHOOSE YOUR DRAWER TYPES
- 3 CHOOSE YOUR DOOR FINISHES
- 4 FILL OUT OUR ORDER FORM



# Index

----- **1. CABINET SPECIFICATIONS** -----

----- **2. DRAWER SPECIFICATIONS** -----

----- **3. DOORS SPECIFICATIONS** -----

----- **4. DOOR FINISHES** -----

----- **5. CABINETS CONFIGURATIONS** -----

----- **6. TECHNICAL SUPPORT INFORMATION** -----

----- **7. TERMS AND CONDITIONS** -----

----- **8. CARE AND MAINTENANCE** -----

----- **9. WARRANTY** -----

----- **10. ORDER FORM** -----

# 1. CABINET SPECIFICATIONS

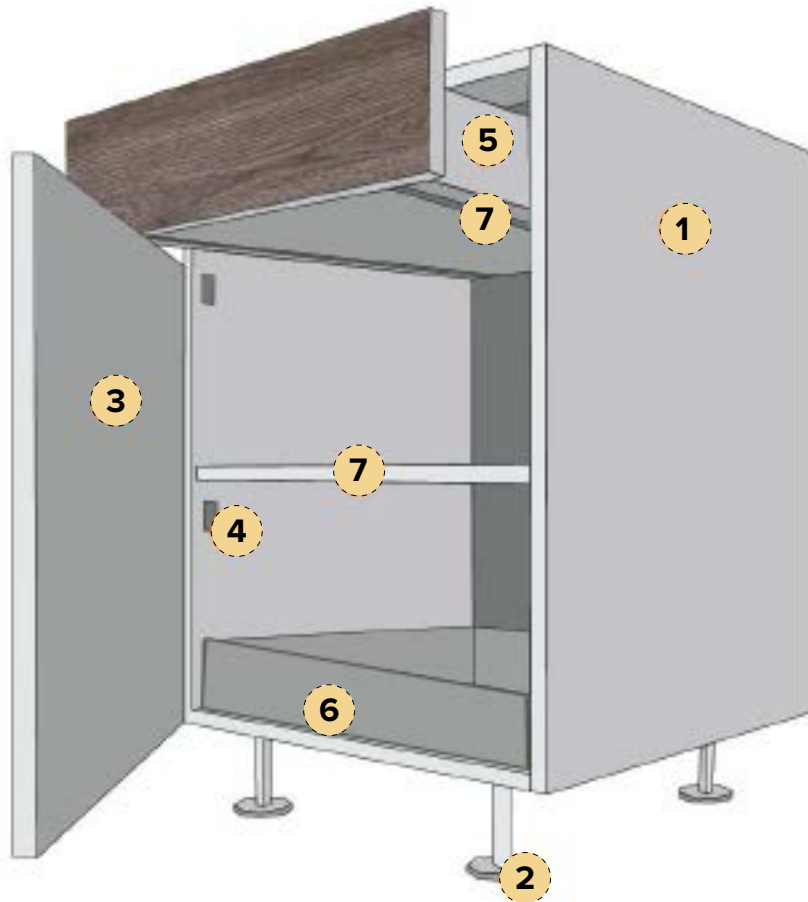

- 1 Confirmat Construction (CQ Default).
- 2 4" Plastic Leg Levelers adjustable from 3 3/4" to 5 3/4" (CQ Default).
- 3 Full Overlay Doors.
- 4 Soft Close Hinges and Soft Close Drawers.
- 5 Doweled or Dovetail Drawers.  
*(item subject to changes based on material availability)*
- 6 4" Doweled or Dovetail Roll Outs. Drawer is sized 1" shorter width on hinge sides.  
Spacer blocks are installed to avoid hinge collision.  
*(item subject to changes based on material availability)*
- 7 Full Depth Shelves.

## BOX MATERIAL

- 1. WHITE MELAMINE
- 2. PREFINISHED MAPLE PLYWOOD
- 3. CUSTOM *(Gray Melamine, Linen...etc)*

All cabinets are **MADE IN USA** and come **ASSEMBLED** with soft close hardware and leg levelers. Cabinets **DO NOT** include finished ends, fillers, toe kick (front) material or handles. All these items will have to be specified and added as part of your order.

## 2. DRAWER SPECIFICATIONS

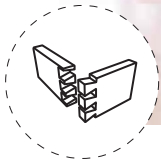

**DOVETAIL**

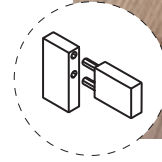

**DOWEL**



**HAFELE Matrix Slim Metal Box**

**UNDERMOUNT DRAWER GUIDES**



# 3. DOOR SPECIFICATIONS

## SLAB DOORS



### MATERIALS & COMMON BRANDS

- 1) MELAMINE  
*Amlam, Egger, Cleaf, etc.*
- 2) HIGH GLOSS COATING  
*Stylelite, etc.*
- 3) MATTE FINISH  
*Fenix, Stylelite, etc.*
- 4) PREFIN. WOOD VENEER  
*Shinnoki, Lignapal, etc.*
- 5) UNF. WOOD VENEER  
*Rift Cut White Oak, Walnut, etc.*
- 6) MDF PAINT GRADE 1S  
*1 Side Paint Grade/1 Side White Liner*
- 7) MDF PAINT GRADE 2S  
*2 Sides Paint Grade*



## 5 PC SHAKER DOORS



### MATERIALS & COMMON BRANDS

- 1) MELAMINE  
*American Laminates, Egger, Cleaf, etc.*
- 2) MATTE FINISH  
*Fenix, Stylelite, etc.*
- 3) UNFINISHED WOOD VENEER  
*Rift Cut White Oak, Walnut, etc.*

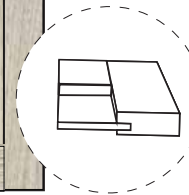

## 1 PC MDF ROUTED SHAKER DOORS



### MATERIALS & COMMON BRANDS

- 1) MDF PAINT GRADE 1S  
*1 Side Paint Grade/1 Side White Liner*
- 2) MDF PAINT GRADE 2S  
*2 Sides Paint Grade*



\*Shaker Style Doors have a minimum width of 8" and a max width of 48". Any doors 8" or smaller will be changed to slab.

\*\*Shaker Style Doors have a minimum height of 8" and a max height of 96". Panels less than 7.5"h will default to a drawer front.

\*\*\*Shaker Style Drawers have a minimum height of 6" and a min width of 8". Drawer Fronts less than min height will default to slab panels and less than min width will default to shaker panel drawer fronts with 1.5" rails.

\*\*\*\*Please contact Cabinets Quick to check any material & sample availability or to place a sample order.

# 4. DOOR FINISHES

## 1. MELAMINE

*Is an excellent choice of material for kitchen doors as it is highly durable, moisture resistant and extremely cost effective.*

### A) AMERICAN LAMINATES EIR COLLECTION

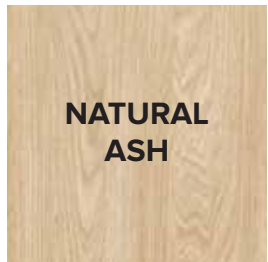
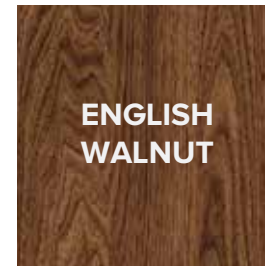
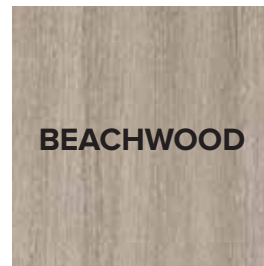
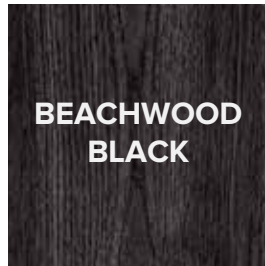
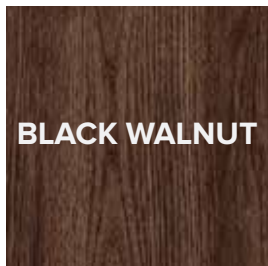

*\*Scan the QR CODE and find out more AMLAM finishes*

# 4. DOOR FINISHES

## B) EGGER



*\*Scan the QR CODE and find out more EGGER finishes*

## C) CLEAF

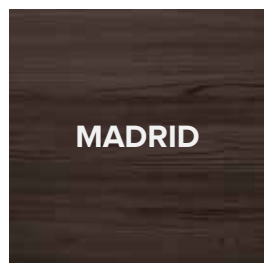
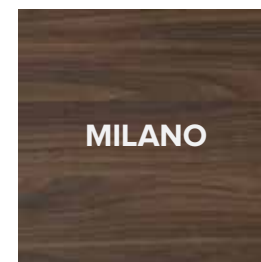
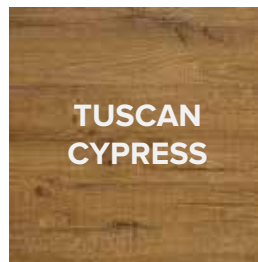
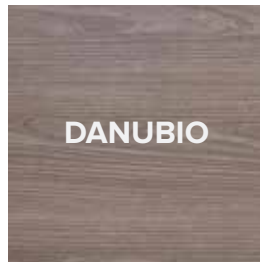
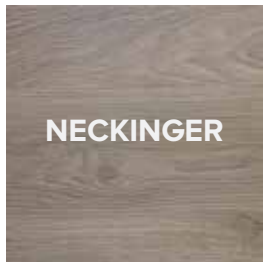

*\*Scan the QR CODE and find out more CLEAF finishes*

## 4. DOOR FINISHES

### 2. HIGH GLOSS STYLELITE

*Is a product that offers a contemporary and highly flexible ultra gloss solution that is both luxurious and affordable. High Gloss Coating delivers a far superior surface finish and appearance compared to high pressure laminate, PET, melamine, paint and RTF and other thinner acrylic laminate.*



*\*Scan the QR CODE and find out  
more STYLELITE finishes*



## 4. DOOR FINISHES

### 3. MATTE FINISH

- A) FENIX** *Ultra Matte Finish have revolutionized the world of interior design. They are a high-tech material, unique by their characteristics by undergoing a particular series of processes, including a multilayer coating and the use of next generation acrylic resins. With low light reflectivity, their surface is extremely opaque, soft touch and anti-fingerprint.*

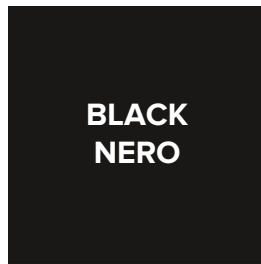
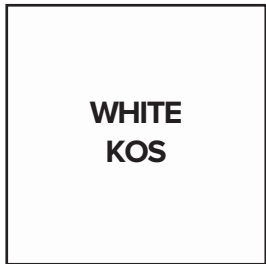

*\*Scan the QR CODE and find out more CLEAF finishes*

- B) STYLELITE TRUMATTE** *Smooth, untextured matte finish, that provides increased scratch resistance over High Gloss surfaces and very low finger printing.*



*\*Scan the QR CODE and find out more CLEAF finishes*

# 4. DOOR FINISHES

## 4. PREFINISHED WOOD VENEERS

### A) SHINNOKI

They are technically a thin layer of hardwood, usually thinner than 1/8 of an inch that is attached to a board. It's not printed, it's real wood and the process yields a durable, clear coating that is resistant to water, heat and highlights the properties and beauty of the wood.

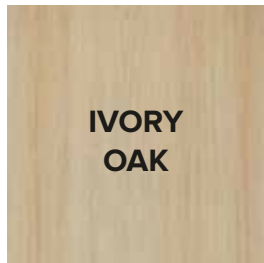

*\*Scan the QR CODE and find out more SHINNOKI finishes*

### B) LIGNAPAL

These veneer sheets have been reinforced by a synthetic resin impregnated backer and given an environmentally friendly lacquer coating finish. The prefinished coating ensures that the warm feeling of real wood comes into its own.

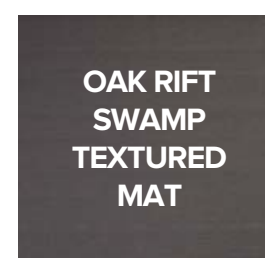
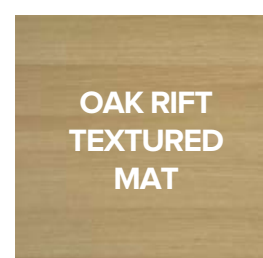

*\*Scan the QR CODE and find out more LIGNAPAL finishes*

## 4. DOOR FINISHES

### 5. UNFINISHED WOOD VENEERS

*Unlike the Prefin. Wood Veneers - the Unfinished Veneer Cabinets - require a second process*

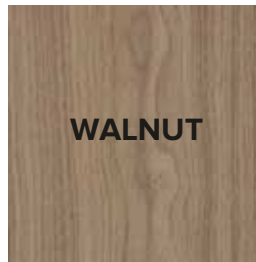

*\*Consult our order entry department to learn more about our finishing options (714) 532 9005*

### 6. PAINT GRADE

*The best possible door for painted applications, our MDF paint-grade doors use only super-refined MDF, providing unrivaled smoothness and finishing.*

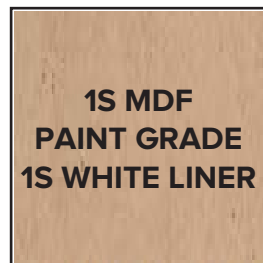

*\*Consult our order entry department to learn more about our finishing options (714) 532 9005*

# 5. CABINET CONFIGURATIONS

STANDARD BASE CABINETS

BASE: 1 SHELF		SKU	DIMENSIONS <i>*BEST PRACTICE SIZES - OPEN FOR CUSTOMIZATION</i>
1 DOOR		B:1SH-1DR	<b>W:</b> from 12" to 24" <b>D:</b> from 12" to 24" <i>*(CQ Default) 24"D + Door = 25"</i> <b>H:</b> 34.5" including 4" leg leveler
2 DOORS		B:1SH-2DR	<b>W:</b> from 24" to 48" <b>D:</b> from 12" to 24" <i>*(CQ Default) 24"D + Door = 25"</i> <b>H:</b> 34.5" including 4" leg leveler

BASE: 2 ROLL OUTS		SKU	DIMENSIONS <i>*BEST PRACTICE SIZES - OPEN FOR CUSTOMIZATION</i>
1 DOOR	Includes: (2) 4" H Roll Outs 	B:2RO-1DR	<b>W:</b> from 12" to 24" <b>D:</b> from 12" to 24" <i>*(CQ Default) 24"D + Door = 25"</i> <b>H:</b> 34.5" including 4" leg leveler
2 DOORS		B:2RO-2DR	<b>W:</b> from 24" to 36" <b>D:</b> from 12" to 24" <i>*(CQ Default) 24"D + Door = 25"</i> <b>H:</b> 34.5" including 4" leg leveler

BASE: 2 SHELVES		SKU	DIMENSIONS <i>*BEST PRACTICE SIZES - OPEN FOR CUSTOMIZATION</i>
1 DOOR		B:2SH-1DR	<b>W:</b> from 12" to 24" <b>D:</b> from 12" to 24" <i>*(CQ Default) 24"D + Door = 25"</i> <b>H:</b> 34.5" including 4" leg leveler
2 DOORS		B:2SH-2DR	<b>W:</b> from 24" to 48" <b>D:</b> from 12" to 24" <i>*(CQ Default) 24"D + Door = 25"</i> <b>H:</b> 34.5" including 4" leg leveler

# 5. CABINET CONFIGURATIONS

## PULL OUT BASE CABINETS

BASE: PULL OUT 2 TIER		SKU	DIMENSIONS <i>*BEST PRACTICE SIZES - OPEN FOR CUSTOMIZATION</i>
1 DOOR		B: PO CQ 2	<b>W:</b> from 7" to 12" <b>D:</b> 24"D + Door = 25" <i>*(CQ Default) 24"D + Door = 25"</i> <b>H:</b> 34.5" including 4" leg leveler



BASE: PULL OUT MAGNETIC KNIFE		SKU	DIMENSIONS <i>*BEST PRACTICE SIZES - OPEN FOR CUSTOMIZATION</i>
1 DOOR	Includes: (1) "No Wiggle" 5" Magnetic Knife Organizer Soft-close Pullout 	B:PO-WDKNIFE	<b>W:</b> from 8" to 12" <b>D:</b> 24"D + Door = 25" <i>*(CQ Default) 24"D + Door = 25"</i> <b>H:</b> 34.5" including 4" leg leveler

BASE: PULL OUT 3 TIER		SKU	DIMENSIONS <i>*BEST PRACTICE SIZES - OPEN FOR CUSTOMIZATION</i>
1 DOOR		B: PO CQ 3	<b>W:</b> from 7" to 12" <b>D:</b> 24"D + Door = 25" <i>*(CQ Default) 24"D + Door = 25"</i> <b>H:</b> 34.5" including 4" leg leveler







# 5. CABINET CONFIGURATIONS

## TOP DRAWER BASE CABINETS

BASE: 1 TOP DRAWER 1 SHELF		SKU	DIMENSIONS <i>*BEST PRACTICE SIZES - OPEN FOR CUSTOMIZATION</i>
1 DOOR	Includes: (1) 6"H Drawer Front with a 4" H Drawer Box 	B:IDWR-1SH-1DR	<b>W:</b> from 12" to 24" <b>D:</b> from 12" to 24" <i>*(CQ Default) 24"D + Door = 25"</i> <b>H:</b> 34.5" including 4" leg leveler
	2 DOORS 		

BASE: 1 TOP DRAWER TRAY		SKU	DIMENSIONS <i>*BEST PRACTICE SIZES - OPEN FOR CUSTOMIZATION</i>
1 DOOR	Includes: (1) 6"H Drawer Front with a 4" H Drawer Box (2) Tray Partitions 	B:IDWR-TR-1DR	<b>W:</b> from 12" to 24" <b>D:</b> from 12" to 24" <i>*(CQ Default) 24"D + Door = 25"</i> <b>H:</b> 34.5" including 4" leg leveler
	2 DOORS 		

BASE: 1 TOP DRAWER 2 ROLL OUTS		SKU	DIMENSIONS <i>*BEST PRACTICE SIZES - OPEN FOR CUSTOMIZATION</i>
1 DOOR	Includes: (1) 6"H Drawer Front with a 4" H Drawer Box (2) 4" H Roll Outs 	B:IDWR-2RO-1DR	<b>W:</b> from 12" to 24" <b>D:</b> from 12" to 24" <i>*(CQ Default) 24"D + Door = 25"</i> <b>H:</b> 34.5" including 4" leg leveler
	2 DOORS 		

BASE: 2 TOP DRAWERS 1 SHELF		SKU	DIMENSIONS <i>*BEST PRACTICE SIZES - OPEN FOR CUSTOMIZATION</i>
1 DOOR	Includes: (2) 6"H Drawer Front with a 4" H Drawer Box 	B:2DWR-1SH-1DR	<b>W:</b> from 12" to 24" <b>D:</b> from 12" to 24" <i>*(CQ Default) 24"D + Door = 25"</i> <b>H:</b> 34.5" including 4" leg leveler
	2 DOORS 		

# 5. CABINET CONFIGURATIONS

## DRAWER BASE CABINETS

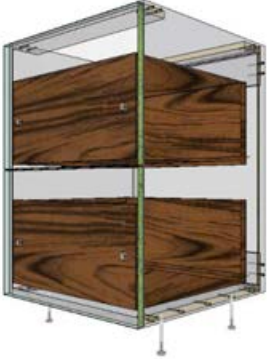
BASE: 2 DRAWERS		SKU	DIMENSIONS <i>*BEST PRACTICE SIZES - OPEN FOR CUSTOMIZATION</i>
<b>2 DRAWER FRONTS</b>	Includes: (2) 15"H Drawer Front with a 10" H Drawer Box	<b>B:2DWR</b>	<b>W:</b> from 12" to 36"  <b>D:</b> from 12" to 24" <i>*(CQ Default) 24"D + Door = 25"</i>  <b>H:</b> 34.5" including 4" leg leveler
			

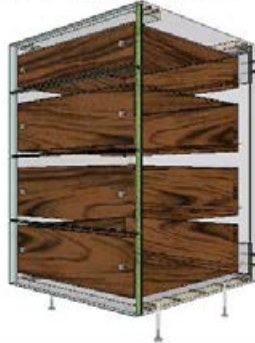
BASE: 4 DRAWERS		SKU	DIMENSIONS <i>*BEST PRACTICE SIZES - OPEN FOR CUSTOMIZATION</i>
<b>4 DRAWER FRONTS</b>	Includes: (1) 6"H Drawer Front with a 4" H Drawer Box (3) 8"H Drawer Front with a 6" H Drawer Box	<b>B:4DWR</b>	<b>W:</b> from 12" to 36"  <b>D:</b> from 12" to 24" <i>*(CQ Default) 24"D + Door = 25"</i>  <b>H:</b> 34.5" including 4" leg leveler
			



BASE: 3 DRAWERS		SKU	DIMENSIONS <i>*BEST PRACTICE SIZES - OPEN FOR CUSTOMIZATION</i>
<b>3 DRAWER FRONTS</b>	Includes: (1) 6"H Drawer Front with a 4" H Drawer Box (2) 12"H Drawer Front with 1x10" and 1x8" H Drawer Box	<b>B:3DWR</b>	<b>W:</b> from 12" to 36"  <b>D:</b> from 12" to 24" <i>*(CQ Default) 24"D + Door = 25"</i>  <b>H:</b> 34.5" including 4" leg leveler
			

BASE: 2 TOP DRAWERS 2 BOTTOM		SKU	DIMENSIONS <i>*BEST PRACTICE SIZES - OPEN FOR CUSTOMIZATION</i>
<b>4 DRAWER FRONTS</b>	Includes: (2) 6"H Drawer Front with a 4" H Drawer Box (2) 12"H Drawer Front with 1x10" and 1x8" H Drawer Box	<b>B:2TDWR-2BM</b>	<b>W:</b> from 12" to 36"  <b>D:</b> from 12" to 24" <i>*(CQ Default) 24"D + Door = 25"</i>  <b>H:</b> 34.5" including 4" leg leveler
			

# 5. CABINET CONFIGURATIONS

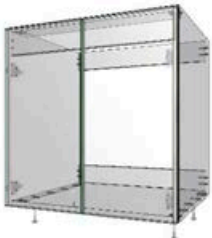
## SINK FALSE FRONT CABINET

<b>SINK BASE</b>		<b>SKU</b>	<b>DIMENSIONS</b> <i>*BEST PRACTICE SIZES - OPEN FOR CUSTOMIZATION</i>
<b>1 DOOR</b>	<p>NOTE: This cabinet is built with NO backs (1) 4"H Internal Apron</p> 	<b>B:SINK-1DR</b>	<p><b>W:</b> from 15" to 24"</p> <p><b>D:</b> 24"D + Door = 25"</p> <p><b>H:</b> 34.5" including 4" leg leveler</p>
<b>2 DOORS</b>		<b>B:SINK-2DR</b>	<p><b>W:</b> from 24" to 42"</p> <p><b>D:</b> 24"D + Door = 25"</p> <p><b>H:</b> 34.5" including 4" leg leveler</p>

<b>BASE SINK: FALSE FRONT</b>		<b>SKU</b>	<b>DIMENSIONS</b> <i>*BEST PRACTICE SIZES - OPEN FOR CUSTOMIZATION</i>
<b>1 DOOR</b>	<p>NOTE: This cabinet is built with NO backs</p> 	<b>B:FF-1DR</b>	<p><b>W:</b> from 15" to 24"</p> <p><b>D:</b> 24"D + Door = 25"</p> <p><b>H:</b> 34.5" including 4" leg leveler</p>
<b>2 DOORS</b>		<b>B:FF-2DR</b>	<p><b>W:</b> from 24" to 42"</p> <p><b>D:</b> 24"D + Door = 25"</p> <p><b>H:</b> 34.5" including 4" leg leveler</p>



# 5. CABINET CONFIGURATIONS

## CORNER BASE CABINETS

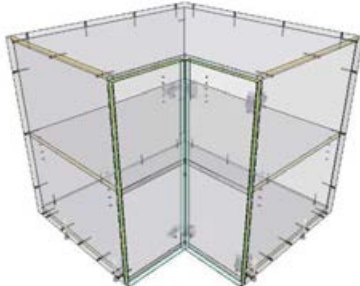

<b>BASE: 90 CORNER 1 SHELF (L/R)</b>		<b>SKU</b>	<b>DIMENSIONS</b> <i>*BEST PRACTICE SIZES - OPEN FOR CUSTOMIZATION</i>
<b>2 DOORS</b>		<b>B:90CL-ISH-1DR</b>	<b>W:</b> 36" or 38"
		<b>B:90CR-ISH-1DR</b>	<b>D:</b> 24"D + Door = 25" <b>H:</b> 34.5" including 4" leg leveler

<b>BASE: 90 CORNER LAZY SUSAN (L/R)</b>		<b>SKU</b>	<b>DIMENSIONS</b> <i>*BEST PRACTICE SIZES - OPEN FOR CUSTOMIZATION</i>
<b>2 DOORS</b>	Includes: (1) Lazy Susan System Hardware with Two White Plastic Kidney Shaped Trays 	<b>B:90CL-LS-1DR</b>	<b>W:</b> 36" or 38"
		<b>B:90CR-LS-1DR</b>	<b>D:</b> 24"D + Door = 25" <b>H:</b> 34.5" including 4" leg leveler

# 5. CABINET CONFIGURATIONS

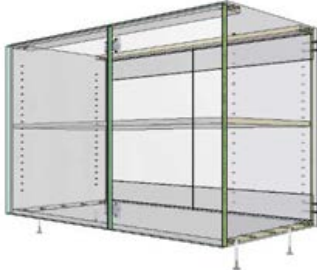
## CORNER BASE CABINETS

BASE: BLIND CORNER 1 SHELF (L/R)		SKU	DIMENSIONS <i>*BEST PRACTICE SIZES - OPEN FOR CUSTOMIZATION</i>
1 DOOR	<p>NOTE: Blind panel width is 27"</p> 	B:BL-1SH-1DR	<b>W:</b> 39" to 48" <b>D:</b> 24"D + Door = 25" <b>H:</b> 34.5" including 4" leg leveler
		B:BR-1SH-1DR	

BASE: BLIND CORNER LEMANS (L/R)		SKU	DIMENSIONS <i>*BEST PRACTICE SIZES - OPEN FOR CUSTOMIZATION</i>
1 DOOR	<p>Includes: (1) LeMans II Set, for Blind Corner Cabinets 45°</p> 	B:BL-LEMANS245L	<b>W:</b> 34" <b>D:</b> 24"D + Door = 25" <b>H:</b> 34.5" including 4" leg leveler
		B:BR-LEMANS245L	
1 DOOR	<p>Includes: (1) LeMans II Set, for Blind Corner Cabinets 50°</p> 	B:BL-LEMANS250L	<b>W:</b> 38" <b>D:</b> 24"D + Door = 25" <b>H:</b> 34.5" including 4" leg leveler
		B:BR-LEMANS250L	
1 DOOR	<p>Includes: (1) LeMans II Set, for Blind Corner Cabinets 60°</p> 	B:BL-LEMANS260L	<b>W:</b> 39.5" <b>D:</b> 24"D + Door = 25" <b>H:</b> 34.5" including 4" leg leveler
		B:BR-LEMANS260L	

# 5. CABINET CONFIGURATIONS

APPLIANCE BASE CABINETS

BASE COOKTOP: FALSE FRONT		SKU	DIMENSIONS <i>*BEST PRACTICE SIZES - OPEN FOR CUSTOMIZATION</i>
2 DRAWER FRONTS	Includes: (2) 9.5"H Drawer Front with a 8" H Drawer Box 	B:CTFF-2DWR	<b>W:</b> from 12" to 30" <b>D:</b> 24"D + Door = 25" <b>H:</b> 34.5" including 4" leg leveler

BASE TRASH UNIT: PULL OUT		SKU	DIMENSIONS <i>*BEST PRACTICE SIZES - OPEN FOR CUSTOMIZATION</i>
1 DOOR	Includes: (1) 30.5"H Drawer Front with 10"H Drawer Box (2) Gray Waste Containers of 35 lbs capacity 	B:GARB-IDR	<b>W:</b> from 12" to 18" <b>D:</b> 24"D + Door = 25" <b>H:</b> 34.5" including 4" leg leveler

BASE MICROWAVE: OPEN		SKU	DIMENSIONS <i>*BEST PRACTICE SIZES - OPEN FOR CUSTOMIZATION</i>
1 DRAWER FRONT	Includes: (1) 12"H Drawer Front with a 8" H Drawer Box 	B:MICRO-NDR	<b>W:</b> from 12" to 30" <b>D:</b> from 18" to 24" <i>*(CQ Default) 24"D + Door = 25"</i> <b>H:</b> 34.5" including 4" leg leveler

BASE TRASH UNIT: 1 DRAWER		SKU	DIMENSIONS <i>*BEST PRACTICE SIZES - OPEN FOR CUSTOMIZATION</i>
1 DOOR	Includes: (1) 6"H Drawer Front with 4"H Drawer Box (2) Gray Waste Containers of 35 lbs capacity 	B:GARB-IDWR-IDR	<b>W:</b> from 12" to 18" <b>D:</b> 24"D + Door = 25" <b>H:</b> 34.5" including 4" leg leveler

BASE MICROWAVE: FALSE FRONT		SKU	DIMENSIONS <i>*BEST PRACTICE SIZES - OPEN FOR CUSTOMIZATION</i>
1 DRAWER FRONT	Includes: (1) 12" H Drawer Front with a 8" H Drawer Box 	B:MICRO-IDR	<b>W:</b> from 12" to 30" <b>D:</b> from 18" to 24" <i>*(CQ Default) 24"D + Door = 25"</i> <b>H:</b> 34.5" including 4" leg leveler



# 5. CABINET CONFIGURATIONS

WALL CABINETS

VERTICAL LIFT WALL CABINET 1 SHELF		SKU	DIMENSIONS <i>*BEST PRACTICE SIZES - OPEN FOR CUSTOMIZATION</i>
1 DOOR	Includes: (1) Swing-Up Fitting Model D	W:V-1SH-1DR	<b>W:</b> 30" to 48"  <b>D:</b> from 8" to 16" <i>*(CQ Default) 13"D + Door = 14"</i>  <b>H:</b> 18", 19", 20" or 24"
			

WALL: BLIND CORNER 2 SHELVES (L/R)		SKU	DIMENSIONS <i>*BEST PRACTICE SIZES - OPEN FOR CUSTOMIZATION</i>
1 DOOR	NOTE: Blind panel width is 16"	W:BL-2SH-1DR	<b>W:</b> 28" to 40"  <b>D:</b> from 8" to 16" <i>*(CQ Default) 13"D + Door = 14"</i>  <b>H:</b> 36", 38" or 40"
			
	W:BR-2SH-1DR	<b>H:</b> 36", 38" or 40"	

VERTICAL LIFT WALL CABINET		SKU	DIMENSIONS <i>*BEST PRACTICE SIZES - OPEN FOR CUSTOMIZATION</i>
1 DOOR	Includes: (1) Swing-Up Fitting Model D	W:V-1DR	<b>W:</b> 30" to 48"  <b>D:</b> from 8" to 16" <i>*(CQ Default) 13"D + Door = 14"</i>  <b>H:</b> 18", 19", 20" or 24"
			

WALL: 2 SHELVES		SKU	DIMENSIONS <i>*BEST PRACTICE SIZES - OPEN FOR CUSTOMIZATION</i>
1 DOOR		W:2SH-1DR	<b>W:</b> from 15" to 24"  <b>D:</b> from 8" to 16" <i>*(CQ Default) 13"D + Door = 14"</i>  <b>H:</b> 36", 38" or 40"
2 DOORS		W:2SH-2DR	<b>W:</b> from 24" to 48"  <b>D:</b> from 8" to 16" <i>*(CQ Default) 13"D + Door = 14"</i>  <b>H:</b> 36", 38" or 40"



# 5. CABINET CONFIGURATIONS

APPLIANCE WALL CABINETS

WALL FRIDGE: LIFT WALL CABINET		SKU	DIMENSIONS <i>*BEST PRACTICE SIZES - OPEN FOR CUSTOMIZATION</i>
1 DOOR	Includes: (1) Swing-Up Fitting Model D	R:V-1DR	<b>W:</b> from 30" to 48" <b>D:</b> from 12" to 24" <i>*(CQ Default) 14"D + Door = 15"</i> <b>H:</b> from 10", 12", 14", 16", 18", 20", 22" or 24" <i>*Recommended Heights - Open to customization)</i>
			

WALL HOOD: LIFT WALL CABINET		SKU	DIMENSIONS <i>*BEST PRACTICE SIZES - OPEN FOR CUSTOMIZATION</i>
1 DOOR		WH:V-1DR	<b>W:</b> from 30" to 48" <b>D:</b> from 12" to 16" <i>*(CQ Default) 13"D + Door = 14"</i> <b>H:</b> from 10" to 27"
			



WALL MICRO: 1 SHELF		SKU	DIMENSIONS <i>*BEST PRACTICE SIZES - OPEN FOR CUSTOMIZATION</i>
2 DOORS		M:IF-1SH-2DR	<b>W:</b> from 30" to 48" <b>D:</b> from 12" to 24" <i>*(CQ Default) 14"D + Door = 15"</i> <b>H:</b> 36", 38" or 40" <i>*Recommended Heights - Open to customization)</i>
			



WALL FRIDGE: NO SHELVES		SKU	DIMENSIONS <i>*BEST PRACTICE SIZES - OPEN FOR CUSTOMIZATION</i>
2 DOORS		R:2DR	<b>W:</b> from 30" to 48" <b>D:</b> from 12" to 24" <i>*(CQ Default) 24"D + Door = 25"</i> <b>H:</b> from 10", 12", 14", 16", 18", 20", 22" or 24" <i>*Recommended Heights - Open to customization)</i>
			

WALL HOOD: NO SHELVES		SKU	DIMENSIONS <i>*BEST PRACTICE SIZES - OPEN FOR CUSTOMIZATION</i>
2 DOORS		WH:2DR	<b>W:</b> from 30" to 48" <b>D:</b> from 12" to 16" <i>*(CQ Default) 13"D + Door = 14"</i> <b>H:</b> from 10" to 27"
			

# 5. CABINET CONFIGURATIONS



## STANDARD TALL CABINETS



TALL: 5 SHELVES		SKU	DIMENSIONS <i>*BEST PRACTICE SIZES - OPEN FOR CUSTOMIZATION</i>
1 DOOR	Includes: (5) Adj. Shelves 	T:5SH-1DR	<b>W:</b> from 12" to 24" <b>D:</b> from 12" to 26" <i>*(CQ Default) 24"D + Door = 25"</i> <b>H:</b> 92", 94" or 96" including 4" leg leveler
2 DOORS		T:5SH-2DR	<b>W:</b> from 24" to 48" <b>D:</b> from 12" to 26" <i>*(CQ Default) 24"D + Door = 25"</i> <b>H:</b> 92", 94" or 96" including 4" leg leveler

TALL: 4 ROLL OUTS 3 SHELVES		SKU	DIMENSIONS <i>*BEST PRACTICE SIZES - OPEN FOR CUSTOMIZATION</i>
1 DOOR	Includes: (3) Adj. Shelves (4) 4"H Roll Outs 	T:3SH-4RO-1DR	<b>W:</b> from 12" to 24" <b>D:</b> from 12" to 26" <i>*(CQ Default) 24"D + Door = 25"</i> <b>H:</b> 92", 94" or 96" including 4" leg leveler
2 DOORS	NOTE: For a more economical option customers can require to switch the roll out material to our newest Metal Roll Out System 	T:3SH-4RO-2DR	<b>W:</b> from 24" to 36" <b>D:</b> from 12" to 26" <i>*(CQ Default) 24"D + Door = 25"</i> <b>H:</b> 92", 94" or 96" including 4" leg leveler

# 5. CABINET CONFIGURATIONS

## STANDARD TALL CABINETS TB

TALL TB: 5 SHELVES		SKU	DIMENSIONS <i>*BEST PRACTICE SIZES - OPEN FOR CUSTOMIZATION</i>
<b>2 DOORS TB</b>	Includes: (4) Adj. Shelves (1) Fixed Shelf   NOTES: <i>*For a more economical option customers can require to switch the roll out material to our newest Metal Roll Out System</i> <i>**Bottom door height is 51 7/8"</i>	<b>T:IFS-4SH-4DR-TB</b>	<b>W:</b> from 12" to 24"  <b>D:</b> from 12" to 26" <i>*(CQ Default) 24"D + Door = 25"</i>  <b>H:</b> 92", 94" or 96" including 4" leg leveler
<b>4 DOORS TB</b>		<b>T:IFS-4SH-4DR-TB</b>	<b>W:</b> from 24" to 48"  <b>D:</b> from 12" to 26" <i>*(CQ Default) 24"D + Door = 25"</i>  <b>H:</b> 92", 94" or 96" including 4" leg leveler

TALL TB: 4 ROLL OUTS 3 SHELVES		SKU	DIMENSIONS <i>*BEST PRACTICE SIZES - OPEN FOR CUSTOMIZATION</i>
<b>2 DOORS TB</b>	Includes: (2) Adj. Shelves (1) Fixed Shelf (4) 4"H Roll Outs   NOTES: <i>*For a more economical option customers can require to switch the roll out material to our newest Metal Roll Out System</i> <i>**Bottom door height is 51 7/8"</i>	<b>T:IFS-2SH-4RO-2DR-TB</b>	<b>W:</b> from 12" to 24"  <b>D:</b> from 12" to 26" <i>*(CQ Default) 24"D + Door = 25"</i>  <b>H:</b> 92", 94" or 96" including 4" leg leveler
<b>4 DOORS TB</b>		<b>T:IFS-2SH-4RO-4DR-TB</b>	<b>W:</b> from 24" to 36"  <b>D:</b> from 12" to 26" <i>*(CQ Default) 24"D + Door = 25"</i>  <b>H:</b> 92", 94" or 96" including 4" leg leveler

# 5. CABINET CONFIGURATIONS

## PULL OUT TALL CABINETS

<b>TALL TB: 4 TIER PULL OUT</b>	<b>SKU</b>	<b>DIMENSIONS</b> <i>*BEST PRACTICE SIZES - OPEN FOR CUSTOMIZATION</i>
<p data-bbox="157 797 184 938" style="writing-mode: vertical-rl; transform: rotate(180deg);"><b>2 DOORS TB</b></p> <p data-bbox="199 462 325 548">Includes: (1) Adj. Shelves (1) Fixed Shelf (4) 4"H Roll Outs</p>  <p data-bbox="199 1198 619 1274"><b>NOTES:</b> <i>*For a more economical option customers can require to switch the roll out material to our newest Metal Roll Out System</i> <i>**Bottom door height is 51 7/8"</i></p>	<p data-bbox="655 727 682 1003" style="writing-mode: vertical-rl; transform: rotate(180deg);"><b>T:PO-1FS-1SH-2DR-TB</b></p>	<p data-bbox="737 764 913 792"><b>W:</b> from 10" to 24"</p> <p data-bbox="737 824 1039 885"><b>D:</b> from 24" to 26" <i>*(CQ Default) 24"D + Door = 25"</i></p> <p data-bbox="737 917 1018 977"><b>H:</b> 92", 94" or 96" including 4" leg leveler</p>



# 5. CABINET CONFIGURATIONS

## APPLIANCE TALL CABINETS



TALL SINGLE OVEN		SKU	DIMENSIONS <i>*BEST PRACTICE SIZES - OPEN FOR CUSTOMIZATION</i>
<b>4 DOORS TB</b>	Notes: (1) Bottom fix to base cabinet height (2) Middle is adjustable. Customer to specify opening (3) Top portion adjust for balance of overall height (4) Customer to order fillers and panels separately if required	<b>O:IFS-2DRTB</b>	<p><b>W:</b> 24" or 30" <i>*Recommended Widths - Open to customization</i></p> <p><b>D:</b> from 24" to 26" <i>** (CQ Default) 24"D + Door = 25"</i></p> <p><b>H:</b> 92", 94" or 96" including 4" leg leveler</p> <p><i>***For additional information please see instructional videos and documentation</i></p>
			





TALL DOUBLE OVEN		SKU	DIMENSIONS <i>*BEST PRACTICE SIZES - OPEN FOR CUSTOMIZATION</i>
<b>2 DOORS TB</b>	Notes: (1) Bottom drawer height is adjustable. Customer to specify. CQ Default is 8" (2) Middle is adjustable. Customer to specify opening (3) Top portion adjust for balance of overall height (4) Customer to order fillers and panels separately if required	<b>O:IFS-1DW-2DR</b>	<p><b>W:</b> 24" or 30" <i>*Recommended Widths - Open to customization</i></p> <p><b>D:</b> from 24" to 26" <i>** (CQ Default) 24"D + Door = 25"</i></p> <p><b>H:</b> 92", 94" or 96" including 4" leg leveler</p> <p><i>***For additional information please see instructional videos and documentation</i></p> <p><i>****Customer to indicate if they require a fixed shelf in the middle opening</i></p>
			

# 5. CABINET CONFIGURATIONS

VANITY CABINETS

VANITY: 1 SHELF		SKU	DIMENSIONS <i>*BEST PRACTICE SIZES - OPEN FOR CUSTOMIZATION</i>
1 DOOR		V:1SH-1DR	<b>W:</b> from 15" to 24" <b>D:</b> from 21" to 24" <i>*(CQ Default) 24"D + Door = 25"</i> <b>H:</b> 34.5" including 4" leg leveler
2 DOORS		V:1SH-2DR	<b>W:</b> from 24" to 48" <b>D:</b> from 21" to 24" <i>*(CQ Default) 24"D + Door = 25"</i> <b>H:</b> 34.5" including 4" leg leveler

VANITY SINK: FALSE FRONT		SKU	DIMENSIONS <i>*BEST PRACTICE SIZES - OPEN FOR CUSTOMIZATION</i>
1 DOOR	NOTE: This cabinet is built with NO backs 	V:S INKFF-1DR	<b>W:</b> from 15" to 24" <b>D:</b> from 21" to 24" <i>*(CQ Default) 24"D + Door = 25"</i> <b>H:</b> 34.5" including 4" leg leveler
2 DOORS		V:SINKFF-2DR	<b>W:</b> from 24" to 36" <b>D:</b> from 21" to 24" <i>*(CQ Default) 24"D + Door = 25"</i> <b>H:</b> 34.5" including 4" leg leveler

VANITY: FALSE FRONT 2 DRAWERS (L/R)		SKU	DIMENSIONS <i>*BEST PRACTICE SIZES - OPEN FOR CUSTOMIZATION</i>
1 DOOR	NOTE: This cabinet is built with NO backs Includes: (2) 10"H Drawer Front with a 8"H Drawer Box 	V:FF-2LDWR-1DR	<b>W:</b> from 30" to 48" <b>D:</b> from 21" to 24" <i>*(CQ Default) 24"D + Door = 25"</i> <b>H:</b> 34.5" including 4" leg leveler
1 DOOR		V:FF-2RDWR-1DR	<b>W:</b> from 30" to 48" <b>D:</b> from 21" to 24" <i>*(CQ Default) 24"D + Door = 25"</i> <b>H:</b> 34.5" including 4" leg leveler
2 DOORS		V:FF-2LDWR-2DR	<b>W:</b> from 30" to 48" <b>D:</b> from 21" to 24" <i>*(CQ Default) 24"D + Door = 25"</i> <b>H:</b> 34.5" including 4" leg leveler
2 DOORS		V:FF-2RDWR-2DR	<b>W:</b> from 30" to 48" <b>D:</b> from 21" to 24" <i>*(CQ Default) 24"D + Door = 25"</i> <b>H:</b> 34.5" including 4" leg leveler

# 5. CABINET CONFIGURATIONS

VANITY CABINETS

VANITY: 2 DRAWERS		SKU	DIMENSIONS <i>*BEST PRACTICE SIZES - OPEN FOR CUSTOMIZATION</i>
2 DRAWER FRONTS	Includes: (2) 15"H Drawer Front with a 10" H Drawer Box	V:2DWR	<b>W:</b> from 12" to 36" <b>D:</b> from 21" to 24" <i>*(CQ Default) 24"D + Door = 25"</i> <b>H:</b> 34.5" including 4" leg leveler
			

VANITY: 3 DRAWERS		SKU	DIMENSIONS <i>*BEST PRACTICE SIZES - OPEN FOR CUSTOMIZATION</i>
3 DRAWER FRONTS	Includes: (1) 6"H Drawer Front with a 4" H Drawer Box (2) 12"H Drawer Front with 1x10" and 1x8" H Drawer Box	V:3DWR	<b>W:</b> from 12" to 36" <b>D:</b> from 21" to 24" <i>*(CQ Default) 24"D + Door = 25"</i> <b>H:</b> 34.5" including 4" leg leveler
			

VANITY: GROOMING ORGANIZER		SKU	DIMENSIONS <i>*BEST PRACTICE SIZES - OPEN FOR CUSTOMIZATION</i>
1 DOOR	Includes: (1) "No Wiggle" Base Cabinet Soft-close Pullout (1) Grooming Organizer Insert for VBPO8-SC	V:POWDGROOMING-1DR	<b>W:</b> from 9" to 13" <b>D:</b> 24"D + Door = 25" <b>H:</b> 34.5" including 4" leg leveler
			

VANITY: MAKE UP BRIDGE		SKU	DIMENSIONS <i>*BEST PRACTICE SIZES - OPEN FOR CUSTOMIZATION</i>
1 DRAWER FRONT	Includes: (1) 6"H Drawer Front with a 4" H Drawer Box	V:PENCIL	<b>W:</b> from 12" to 36" <b>D:</b> from 12" to 24" <i>*(CQ Default) 24"D + Door = 25"</i> <b>H:</b> 6 3/8"
			

# 5. CABINET CONFIGURATIONS

FILLERS AND PANELS

BASE FILLER (L/R)	SKU	DIMENSIONS <i>*BEST PRACTICE SIZES - OPEN FOR CUSTOMIZATION</i>
	BASE FILLER L	<b>W:</b> 2" <i>*Filler will always come 1" wider than ordered</i>
	BASE FILLER R	<b>H:</b> 30.5" <i>**It will not go to the floor</i> <i>***Filler will adjust with the toe kick height</i>

GENERIC PANEL	SKU	DIMENSIONS <i>*BEST PRACTICE SIZES - OPEN FOR CUSTOMIZATION</i>
	BASE FINISH END PANEL	<i>*Customer to indicate specific sizes ( W and H )</i>

BASE APPLIED END PANEL	SKU	DIMENSIONS <i>*BEST PRACTICE SIZES - OPEN FOR CUSTOMIZATION</i>
	BASE APPLIED END	<b>W:</b> from 12" to 25" <b>H:</b> 34 1/8" <i>*Intended to sit on the floor. The height maintains the 3/8" top reveals.</i> <i>**Customer to indicate specific sizes</i>

BASE APPLIED END J PANEL (L/R)	SKU	DIMENSIONS <i>*BEST PRACTICE SIZES - OPEN FOR CUSTOMIZATION</i>
	BASE: APPLIED END - J LEFT/RIGHT	<b>W:</b> from 1.5" to 6" <i>*(CQ Default) is 2"</i> <b>D:</b> from 12" to 25" <i>** (CQ Default) is 25"</i> <b>H:</b> 34 1/8" <i>***Intended to sit on the floor. The height maintains the 3/8" top reveals.</i> <i>****Customer to indicate specific sizes</i>

BASE DOOR PANEL	SKU	DIMENSIONS <i>*BEST PRACTICE SIZES - OPEN FOR CUSTOMIZATION</i>
	BASE DOOR PANEL	<b>W:</b> from 12" to 25" <b>H:</b> 34 1/8" <i>*Intended to sit on the floor. The height maintains the 3/8" top reveals.</i> <i>**Customer to indicate specific sizes</i>

BASE APPLIED END L PANEL (L/R)	SKU	DIMENSIONS <i>*BEST PRACTICE SIZES - OPEN FOR CUSTOMIZATION</i>
	BASE: APPLIED END - L LEFT/RIGHT	<b>W:</b> from 1.5" to 6" <i>*(CQ Default) is 2"</i> <b>D:</b> from 12" to 25" <i>** (CQ Default) is 25"</i> <b>H:</b> 34 1/8" <i>***Intended to sit on the floor. The height maintains the 3/8" top reveals.</i> <i>****Customer to indicate specific sizes</i>



# 5. CABINET CONFIGURATIONS

FILLERS AND PANELS

BASE DOUBLE J ISLAND END PANEL (L/R)	SKU	DIMENSIONS <i>*BEST PRACTICE SIZES - OPEN FOR CUSTOMIZATION</i>
	BASE END MTR ISL L/R	<p><b>W:</b> from 1.5" to 6" <i>*(CQ Default) is 2"</i></p> <p><b>D:</b> from 12" to 47" <i>**Customer to specify size (it could be wider for non grain materials)</i></p> <p><b>H:</b> 34 1/8" <i>***Intented to sit on the floor. The height maintains the 3/8" top reveals.</i> <i>****Customer to specify size</i></p>

WALL FINISHED END PANEL	SKU	DIMENSIONS <i>*BEST PRACTICE SIZES - OPEN FOR CUSTOMIZATION</i>
	WALL FINISH END PANEL	<p><b>W:</b> from 8" to 16"</p> <p><b>H:</b> 36", 38" or 40" <i>*Customer to indicate specific sizes</i></p>

ISLAND PANELS (L/R)	SKU	DIMENSIONS <i>*BEST PRACTICE SIZES - OPEN FOR CUSTOMIZATION</i>
	ISLAND PANELS L/R	<p><i>*Customer to indicate specific sizes ( <b>W</b> and <b>H</b> )</i></p>

WALL DOOR PANEL	SKU	DIMENSIONS <i>*BEST PRACTICE SIZES - OPEN FOR CUSTOMIZATION</i>
	WALL FINISH END PANEL	<p><b>W:</b> from 8" to 16"</p> <p><b>H:</b> 36", 38" or 40" <i>*Customer to indicate specific sizes</i></p>

WALL FILLER (L/R)	SKU	DIMENSIONS <i>*BEST PRACTICE SIZES - OPEN FOR CUSTOMIZATION</i>
	WALL FILLER L	<p><b>W:</b> 2" <i>*Filler will always come 1" wider than ordered</i></p>
	WALL FILLER R	<p><b>H:</b> 36", 38" or 40" <i>**Filler will adjust with the wall height</i></p>

WALL APPLIED END L PANEL (L/R)	SKU	DIMENSIONS <i>*BEST PRACTICE SIZES - OPEN FOR CUSTOMIZATION</i>
	BASE: APPLIED END - L LEFT / RIGHT	<p><b>W:</b> from 1.5" to 6" <i>*(CQ Default) is 2"</i></p> <p><b>D:</b> from 8" to 16" <i>** (CQ Default) is 14"</i></p> <p><b>H:</b> 36", 38" or 40" <i>***Customer to indicate specific sizes</i></p>

# 5. CABINET CONFIGURATIONS

FILLERS AND PANELS

TALL FILLER (L/R)	SKU	DIMENSIONS <i>*BEST PRACTICE SIZES - OPEN FOR CUSTOMIZATION</i>
	TALL FILLER L	<b>W:</b> 2" <i>*Filler will always come 1" wider than ordered</i>
	TALL FILLER R	<b>H:</b> 88", 90" or 92" <i>**it will not go up to the floor</i> <i>***Filler will adjust with the toe kick height</i>

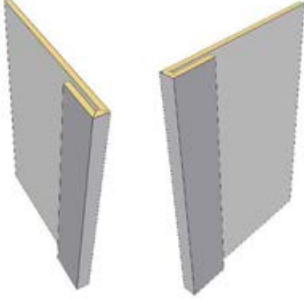
TALL APPLIED END J PANEL (L/R)	SKU	DIMENSIONS <i>*BEST PRACTICE SIZES - OPEN FOR CUSTOMIZATION</i>
	TALL APPLIED END - J LEFT/RIGHT	<b>W:</b> from 1.5" to 6" <i>*(CQ Default) is 2"</i>  <b>D:</b> from 12" to 26" <i>** (CQ Default) is 25"</i>  <b>H:</b> 92", 94" or 96" <i>***Intended to sit on the floor. The height maintains the 3/8" top reveals.</i> <i>****Customer to indicate specific sizes</i>

TALL FINISHED END PANEL	SKU	DIMENSIONS <i>*BEST PRACTICE SIZES - OPEN FOR CUSTOMIZATION</i>
	TALL FINISH END PANEL	<b>W:</b> from 12" to 26" <i>*(CQ Default) is 25"</i>  <b>H:</b> 92", 94" or 96" <i>**Intended to sit on the floor. The height maintains the 3/8" top reveals.</i> <i>***Customer to indicate specific sizes</i>

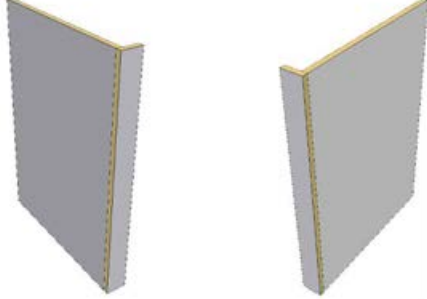
TALL APPLIED END L PANEL (L/R)	SKU	DIMENSIONS <i>*BEST PRACTICE SIZES - OPEN FOR CUSTOMIZATION</i>
	BASE END MTR ISL L/R	<b>W:</b> from 1.5" to 6" <i>*(CQ Default) is 2"</i>  <b>D:</b> from 12" to 26" <i>** (CQ Default) is 25"</i>  <b>H:</b> 92", 94" or 96" <i>***Intended to sit on the floor. The height maintains the 3/8" top reveals.</i> <i>****Customer to indicate specific sizes</i>

TALL DOOR PANEL	SKU	DIMENSIONS <i>*BEST PRACTICE SIZES - OPEN FOR CUSTOMIZATION</i>
	TALL FINISH END PANEL	<b>W:</b> from 12" to 26" <i>*(CQ Default) is 25"</i>  <b>H:</b> 92", 94" or 96" <i>**Intended to sit on the floor. The height maintains the 3/8" top reveals.</i> <i>***Customer to indicate specific sizes</i>

CROWN - CEILING SCRIBE	SKU	DIMENSIONS <i>*BEST PRACTICE SIZES - OPEN FOR CUSTOMIZATION</i>
	CROWN	<b>W:</b> 96"  <b>H:</b> 2" <i>*Customer to indicate specific sizes</i> <i>**Intended to be installed flush with the door. Comes with 3/4" backing material.</i>

# 5. CABINET CONFIGURATIONS

FILLERS AND PANELS

DISWASHER FRONT PANEL	SKU	DIMENSIONS <i>*BEST PRACTICE SIZES - OPEN FOR CUSTOMIZATION</i>
	B: DISWASHER FRONT PANEL	<b>W:</b> 3/4" <i>*Customer to specify sizes (D and H)</i>

FRIDGE FRONT PANEL	SKU	DIMENSIONS <i>*BEST PRACTICE SIZES - OPEN FOR CUSTOMIZATION</i>
	T: FRIDGE FRONT PANEL	<b>W:</b> 3/4" <i>*Customer to specify sizes (D and H)</i>

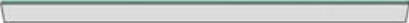
LIGHT BALANCE	SKU	DIMENSIONS <i>*BEST PRACTICE SIZES - OPEN FOR CUSTOMIZATION</i>
	LIGHT BALANCE	<b>W:</b> 96" <b>H:</b> 2" (CQ Default) <i>*Customer to indicate specific sizes</i>

TOE KICK	SKU	DIMENSIONS <i>*BEST PRACTICE SIZES - OPEN FOR CUSTOMIZATION</i>
	TOE KICK	<b>W:</b> 96" <b>H:</b> 4" <i>*Customer to indicate specific sizes</i>

# 6. TECHNICAL SUPPORT INFORMATION

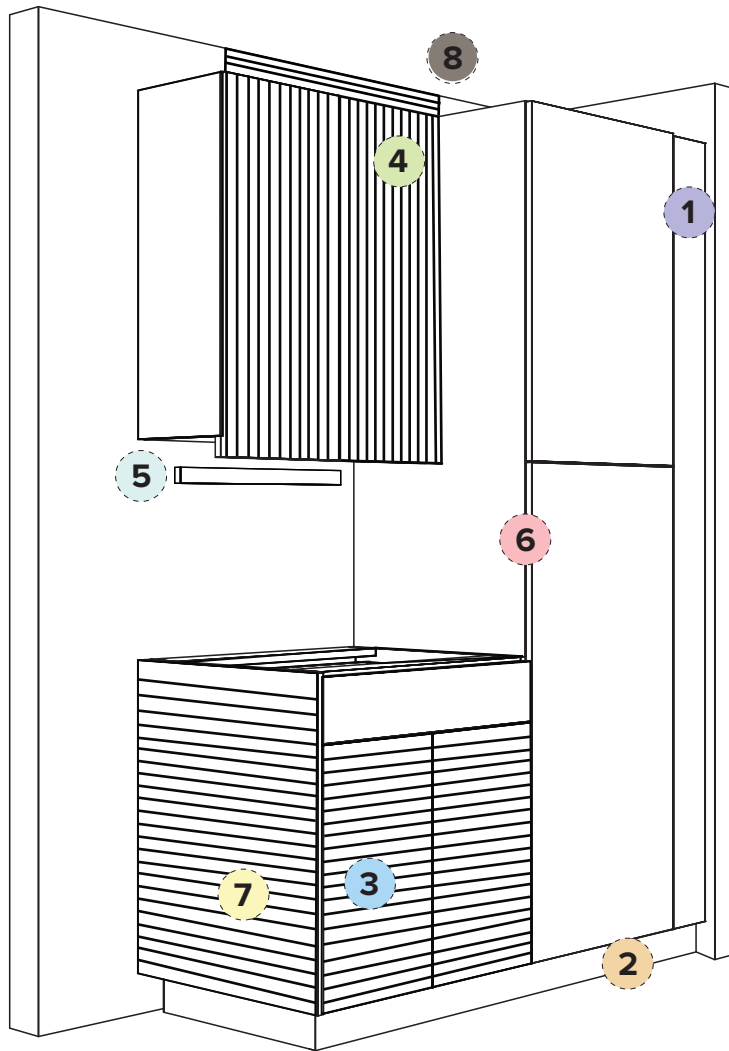

- 1 Filler
- 2 Toe Kicks
- 3 Horizontal Grain
- 4 Vertical Grain
- 5 Light Valance
- 6 Edge Banding
- 7 Finish End
- 8 Ceiling Scribe



**FILLERS (PER CABINET)**

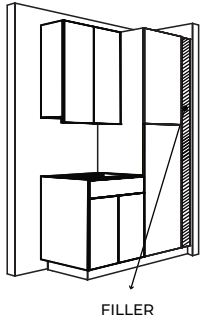

- Standard filler width will be 2". CQ will ship 1" oversize fillers. You will be getting 3" fillers to be cut on field.
- Fillers material will match the door material. Will also match the door height including the reveals.
- Fillers will be finished on all 4 sides.
- Is intended to be flush with the cabinet door. All wooden parts needed for installation will be provided. (3M panel adhesive and 3M tape not provided - see filler instructions)

**LIGHT VALANCE**

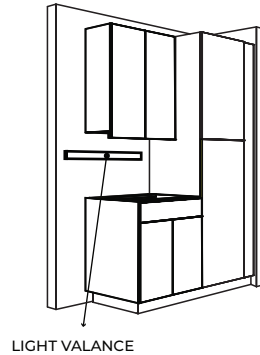

- Light Valance is typically a 2" space on the bottom of the cabinet intended to cover and hide the under-counting lighting.
- There are several ways to do a light valance. Consult our experts for more information.
- CQ will not provide light valance unless specified.

**TOE KICK PARTS**

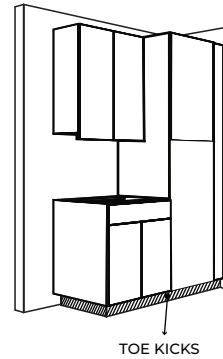

- Standard height is 4".
- Toe kick heights in prints are reflected from finish floor height.
- The 4" Plastic Leg Levelers can be adjustable from 3 3/4" up to 6".
- CQ default to install toe bases on the finished floor.

**GRAIN MATCH**

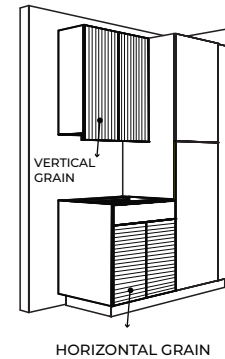

- Grain will continue across cabinet doors per cabinet only.
- Options available: vertical and horizontal grain.
- CQ default is vertical grain match.

**CABINET DRILL LINE (BORE)**

- CQ default is bore by opening.
- Other option available only by request: bore only required holes (5 holes per shelf).



**HINGES & HINGE PLATES**

- CQ default is to provide soft-close hinges with all ordered doors.
- CQ reserve the right to supply and select any hardware that we deem appropriate.

**DRAWER GUIDES**

- CQ default is to provide soft-close guides with all ordered drawer cabinets.
- CQ reserve the right to supply and select any hardware that we deem appropriate.

# 7. TERMS AND CONDITIONS



**PAYMENT.** A 50% deposit on all orders, due at the time of acknowledgment of approval. The deposit must be received prior to production. We require that the remaining balance must be paid prior to pick up or shipment. Deposit and/or final payment may be made by: Cash, Check, Cashiers Check, Credit Card. We accept Visa and Master Card. If sending a check or cashiers check, orders may be delayed until funds clear the bank.

**Please note, absence of a deposit will delay production and absence of final payment will delay pick up or shipping.**

**ORDER PROCESSING.** Phone orders are not accepted due to the many errors that may arise from miscommunication. Please check your order form carefully for item size, quantity, color, etc. Your order will be processed sent for your acknowledgment, which must be signed and returned.

**REVISIONS.** Your order or estimate will be entered and then allow first and second customer revision ( acknowledgment ) for no additional charge. Any additional customer required revisions will require a fee of \$60 per revision cycle. Each time an order or estimate is revised it will be re-acknowledged. Any revision charges will be clearly shown on the latest acknowledgment.

**LEAD TIME.** Lead time varies depending on the current production schedule. More accurate lead times will be given when order is approved. Every reasonable attempt to ship by projected ship date will be made, but may be affected by special ordered material, non-payment of deposit, numerous revisions to an order, etc.

**RUSH ORDER SERVICES.** Rush Orders will be available for orders under 50 cabinet. Rush orders may be requested, but availability is not always guaranteed. Rush Order requests may be made for an additional 25%, with the minimum fee being \$500.

**CHANGES TO APPROVED ORDERS.** Requested revisions after an order is signed and approved by customer are never guaranteed. If the order is already in production, customers will incur a net charge based on time and any materials which may be affected.

**SHIPPING AND HANDING.** Because of the nature of our custom orders, it is impossible to determine the exact cost for shipping each order until the order is completed. We strive to provide our customers with the safest and most affordable means in all deliveries. Please be advised that delivery is not included in the price of the cabinets and all shipping charges are the responsibility of the customer. Customer should verify that the delivery truck can safely drive on all roads leading up to delivery destination. If inaccessible for any reason deemed necessary by the driver, customer is responsible for picking up their order from the shipping distribution center.

**DELIVERY AND INSPECTION.** Buyer shall have the right to inspect the goods with in five (5) days of delivery at the shipping address. Please note, after 5 days any order discrepancies are void. No exceptions. All products leave our factory in good condition and properly packaged. All claims for damaged or broken merchandise must be made through carrier. Any damage that is apparent up on delivery must be noted over the freight carrier delivery receipt. If the damage is severe ,we recommend you refuse the shipment entirely. All claims for damaged or broken merchandise must be made through carrier.

**INSTALLATION.** We do not accept responsibility or liability for installation of any product. We recommend using a professional installer for best results. Cabinets Quick is not responsible for problems arising from improper installation, use or care.

# 8. WARRANTY



## LIMITED LIFETIME WARRANTY

Cabinets Quick here by warrants to the first and original purchaser, for residential applications only, that all cabinets, including system hardware, are free from defects in materials and workmanship for a period of (10) years and all doors and drawer fronts for a period of (1) year. This warranty is expressly limited to repair or replacement of the defective part at the sole discretion of Cabinets Quick and does not include labor for removal or replacement. This warranty does not extend to defects caused by improper handling, storage, installation, assembly or disassembly, intentional damage, product modifications, exposure to the elements including humidity which may result in warping or splitting, accidental misuse, abuse or negligence.

LIFETIME. Cabinets Quick offers a lifetime warranty for all Soft Close Hinges and Drawer Guides. This warranty runs for as long as you own your cabinets and begins upon the date of delivery to you.

**Heat & Humidity.** Various cooking appliances produce a lot of heat or humidity. It is very important to make sure these products are positioned so rising heat is not trapped or confined. Thermofoil and edge-banding on doors cannot be exposed to temperatures beyond 170 degrees for extended periods of time without risking permanent damage, which are not covered under the warranty.

**Sunlight and Aging.** Materials may vary in texture, color and wood grain, and exhibit subtle changes as they age. For example, wood joints may eventually have visible cracking around the joint area and cabinet colors may darken or lighten over time. Sunlight, smoke, moisture, household cleaners and other environmental conditions may cause materials to vary from their original color and/or to warp, split or crack. These variations are considered to be the nature of the material in relation to their environmental exposure and are not covered under this warranty.

Cabinets Quick makes no other warranties other than those set forth herein and all other warranties are hereby disclaimed. The implied warranties of merchantability and fitness for a particular purpose are limited in duration to the length of the limited warranty period. The limited warranties set forth herein are restricted to the first and original buyer and are not transferable thereafter. In no event shall Cabinets Quick be liable for incidental or consequential damages to the purchaser or to any third party, including, without limitation, damages arising from personal injury, lost profits, loss of business opportunity, loss of property, economic losses, or statutory or exemplary damages, whether from negligence, warranty, strict liability or otherwise. Some states do not allow the exclusion or limitation of incidental or consequential damages, or limitations on how long an implied warranty lasts, so the above limitations and exclusions may not apply to you. This warranty gives you specific legal rights, and you may also have other rights which vary from state to state. All claims for defective cabinets and accessories must be submitted to Cabinets Quick in writing and must specify the defects present in the cabinets and accessories. After Cabinets Quick has had an opportunity to inspect the cabinets and accessories, they will, at their sole discretion, either replace effective cabinets and accessories or repair any defects in the cabinets and accessories.

# 9.CARE AND MAINTENANCE



**EVERY DAY CARE.** It is important to wipe up spills and water marks as they occur. Give special attention to care as around the sink and dishwasher. Avoid draping damp or wet dish towels over the door of a sink base cabinet. Over time, this moisture can cause permanent water damage to the door. A convenient, out-of-the-way sliding towel rack is recommended.

**DUSTING.** Dust cabinets frequently with a soft lint-free cloth. You can dampen the cloth slightly with water or spray-type dust remover.

**SPILLS.** Clean spills immediately. Use a clean cloth and mild soap if necessary. Wipe dry with a clean soft cloth.

**CLEANING.** There are a number of products available for your wood cleaning needs. Many wood cleaning products are available at many stores nation wide including Bed Bath & Beyond, Walmart and Ace Hardware. A more economical way to remove grease build up over cabinets is to use Fantastik. Apply and remove quickly, then wash your cabinets with a mild soap. After washing, dry thoroughly.

**DON'T.** Never use detergents, soap pads or steel wool on your cabinetry. These harsh abrasives will mar the wood finish. Additionally, we recommend that you avoid the use of paste wax and polishes that contain silicone; the wax build up is difficult to remove and will leave a residue that attracts dust.

**ACRYLIC.** Never use Acetone or Ammonia-based product son Acrylic Panels. Wipe with scratch resistant microfiber clothes with mild detergents ONLY. In the event that your surfaces gets crotched, you may purchase one of our scratch kits.

* PROJECT NAME:	* CONTACT NAME:	* QUOTE DUE DATE:
* COMPANY NAME:	* PHONE:	EMAIL:
* CONTACT ADDRESS:	* PROJECT STATUS: <input type="checkbox"/> GENERAL BIDDING <input type="checkbox"/> PROJECT IN PROGRESS	
<input type="checkbox"/> BY SELECTING THIS OPTION CABINETS QUICK WILL FOLLOW OUR TYPICAL CONSTRUCTION STANDARDS <b>(CQ DEFAULT)</b> ONLY DOOR <b>MATERIALS</b> WILL NEED TO BE SELECTED.		

**DISCLOSURE:** All quotes and drawings are Cabinets Quick's property until the job is approved. All quotes are free of charge. A maximum of 2 changes per quote will be allowed. For more than 2 changes per quote a deposit will be required. CQ defaults are designed to give you a configuration that will serve well for most applications. The Rest of options displayed here are not upgrades but are alternatives to the CQ defaults. For upgrades or any additional instructions regarding your project please contact our office by phone or email.

**A) PROVIDE DOORS, FILLERS, CEILING SCRIBE**  YES  NO If **YES** please select from the options bellow:

<input type="checkbox"/> <b>SLAB DOORS</b> <input type="checkbox"/> <b>Melamine</b> (American Laminates, Egger, Cleaf, etc.) color: _____ <input type="checkbox"/> <b>High Gloss Coating</b> (Stylelite, etc.) color: _____ <input type="checkbox"/> <b>Matte Finish</b> (Fenix, Stylelite, etc.) color: _____ <input type="checkbox"/> <b>Prefinished Wood Veneers</b> (Shinnoki, Lignapal, etc.) color: _____ <input type="checkbox"/> <b>Unfin. Wood Veneers</b> (Rift Cut White Oak, Walnut, etc.) color: _____ <input type="checkbox"/> <b>1 PC. MDF Slab Door</b> <input type="checkbox"/> 2S Paint Grade <input type="checkbox"/> 1S/1S White Liner	<input type="checkbox"/> <b>5 PC. SHAKER DOORS</b> <input type="checkbox"/> <b>Melamine</b> (American Laminates, Egger, Cleaf, etc.) color: _____ <input type="checkbox"/> <b>Matte Finish</b> (Fenix, Stylelite, etc.) color: _____ <input type="checkbox"/> <b>Unfinished Wood Veneers</b> (Rift Cut White Oak, Walnut, etc.) color: _____ <input type="checkbox"/> <b>1 PC. MDF ROUTED SHAKER DOORS</b> When selected this door type please specify which option from below is required for your project: <input type="checkbox"/> 2S Paint Grade <input type="checkbox"/> 1S/1S White Liner	<input type="checkbox"/> <b>5 PC. SHAKER GLASS DOORS</b> <input type="checkbox"/> <b>Melamine</b> (American Laminates, Egger, Cleaf, etc.) color: _____ <input type="checkbox"/> <b>Matte Finish</b> (Fenix, Stylelite, etc.) color: _____ <input type="checkbox"/> <b>Unfinished Wood Veneers</b> (Rift Cut White Oak, Walnut, etc.) color: _____
------------------------------------------------------------------------------------------------------------------------------------------------------------------------------------------------------------------------------------------------------------------------------------------------------------------------------------------------------------------------------------------------------------------------------------------------------------------------------------------------------------------------------------------------------------------------------------------------------------------------------------------------------------------------------------------------	-------------------------------------------------------------------------------------------------------------------------------------------------------------------------------------------------------------------------------------------------------------------------------------------------------------------------------------------------------------------------------------------------------------------------------------------------------------------------------------------------------------------------------------------------------------------------------------------------------------------------------	----------------------------------------------------------------------------------------------------------------------------------------------------------------------------------------------------------------------------------------------------------------------------------------------------------------------------------------------------------------------

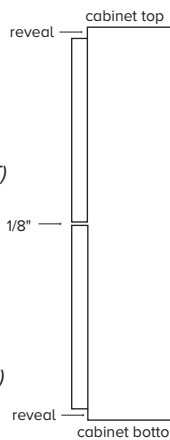
B) CABINETS MATERIALS	D) PROVIDE DRAWERS	E) CABINETS CONSTRUCTION	F) OTHER FEATURES
<input type="checkbox"/> White Melamine (CQ DEFAULT) <input type="checkbox"/> Prefinished Maple Plywood <input type="checkbox"/> Custom (Gray Melamine, Linen...etc) color: _____ <hr/> <b>C) EDGEBANDING</b> <b>CABINET BOX FACE</b> <input type="checkbox"/> Match Cabinet Material (CQ DEFAULT) <input type="checkbox"/> Upgrade to Match Door <input type="checkbox"/> Others _____	<input type="checkbox"/> YES (CQ DEFAULT) <input type="checkbox"/> NO If <b>YES</b> please select from the followings: <hr/> <input type="checkbox"/> 1/2" Baltic Birch Dovetail Construction (CQ DEFAULT) <input type="checkbox"/> 5/8" Solid Wood Maple Prefinished Dovetail Construction <input type="checkbox"/> 5/8" Prefin Maple Dowel Construction <input type="checkbox"/> 5/8" Melamine Dowel Construction <input type="checkbox"/> White (CQ DEFAULT) <input type="checkbox"/> Gray <input type="checkbox"/> HAFELE Metal Slim A <input type="checkbox"/> Upgrade BLUM Legrabox	<input type="checkbox"/> Confirmat Construction (CQ DEFAULT) <b>DOOR REVEALS</b> A) BASE CABINETS Top: 3/8" (CQ DEFAULT) <input type="checkbox"/> Other _____ Bottom: 0" (CQ DEFAULT) <input type="checkbox"/> Other _____ B) WALL HUNG UPPER AND TALL CABINETS Top: 1/8" (CQ DEFAULT) <input type="checkbox"/> Other _____ Bottom: 0" (CQ DEFAULT) <input type="checkbox"/> Other _____ 	<b>DELIVER THE PROJECT</b> <input type="checkbox"/> YES <input type="checkbox"/> NO (WILL CALL - CQ DEFAULT) <small>*Shipping price will be determined after finished job is weighed.</small> <hr/> <b>ASSEMBLED PROJECT</b> <input type="checkbox"/> YES (CQ DEFAULT) <input type="checkbox"/> NO (FLAT STACKED) <hr/> <b>GRAIN MATCH</b> <input type="checkbox"/> YES (CQ DEFAULT) <input type="checkbox"/> NO <hr/> <b>LIGHT VALANCE</b> <input type="checkbox"/> YES (Valance molding under the cabinet) <input type="checkbox"/> YES (Recessed bottom behind the doors) <input type="checkbox"/> NO (CQ DEFAULT)

Company Name

Project Name or Number

Room Name or Number

Cabinets Quick SKU #

Quantity

Width

Height

Depth (excluding doors)

Hinging: L, R, P(pair), O(open)

Finished Ends: L, R, B(oth)

# of Adjustable Shelves

# of Drawer Fronts

Specify Drawer Front Height

MAKE COMMENTS  
 ADD ADDITIONAL INSTRUCTIONS  
 inset apron, false front,  
 panels, fillers, need for edgebanding, etc.

Cabinets Quick SKU #	Quantity	Width	Height	Depth (excluding doors)	Hinging: L, R, P(pair), O(open)	Finished Ends: L, R, B(oth)	# of Adjustable Shelves	# of Drawer Fronts	Specify Drawer Front Height	MAKE COMMENTS ADD ADDITIONAL INSTRUCTIONS inset apron, false front, panels, fillers, need for edgebanding, etc.

Use this area to give us additional information and details as needed. NOTE: Provide INSIDE CLEAR dimensions or send sketch/CAD drawings for custom cabinets.

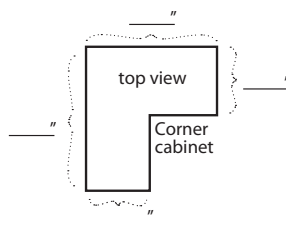

**STANDARD BASE CABINETS**

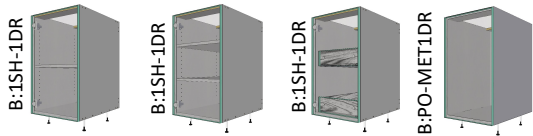

**TOP DRAWER BASE CABINETS**

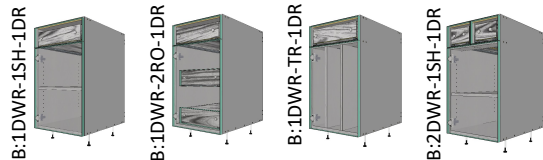

**DRAWER BASE CABINETS**

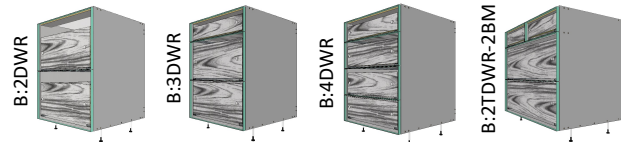

**PULL OUT CABINETS**

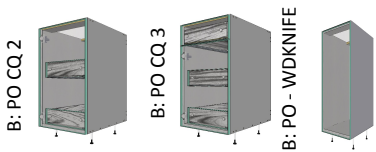

**SINK FALSE FRONT CABINETS**

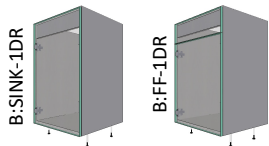

**CORNER BASE CABINETS**

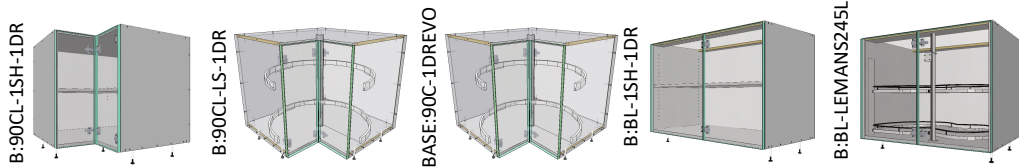

B:BL-LEMANS245L

**STANDARD WALL CABINETS**

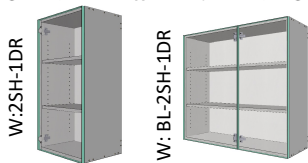

**VERTICAL LIFT WALL CABINETS**

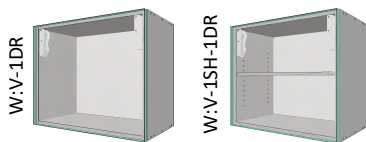

**STANDARD TALL CABINETS**

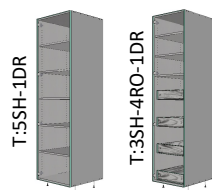

**STANDARD TALL CABINETS TB**

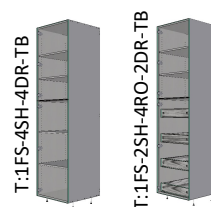

**PULL OUT TALL CABINETS TB**



**VANITY CABINETS**

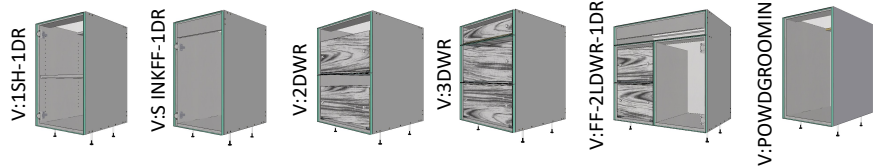

V:POWDGROOMING-1DR

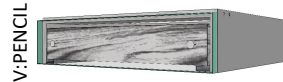

**APPLIANCE CABINETS**

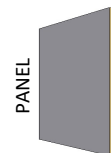
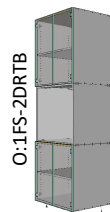
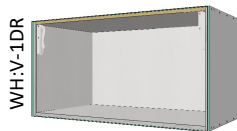
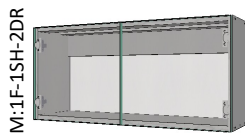
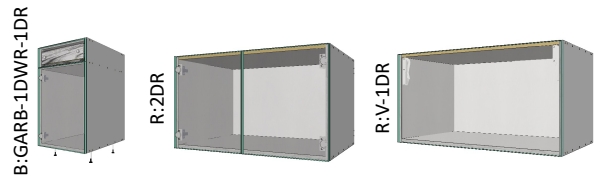
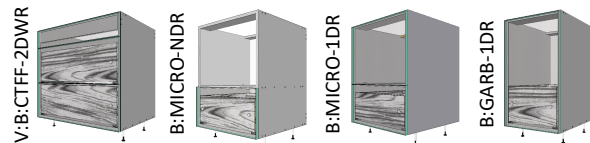

**FILLERS AND PANELS**

